

Seismic Renovation Project Feasibility Report

**GEORGE E. MCDONALD HALL
OF JUSTICE
01-F1**

2233 SHORELINE DR., ALAMEDA

SUPERIOR COURT OF
CALIFORNIA, COUNTY OF
ALAMEDA

PREPARED BY ARUP
JANUARY 22, 2019



**JUDICIAL COUNCIL
OF CALIFORNIA**

ADMINISTRATIVE DIVISION
FACILITIES SERVICES

Contents

I.	EXECUTIVE SUMMARY	1
II.	INTRODUCTION	2
	A. Background and Context	2
	B. Summary of Project Approach	2
	C. Report Organization	4
III.	EXISTING BUILDING CHARACTERISTICS.....	6
	A. General Information	6
	B. Overview of Critical Seismic Deficiencies	9
	C. Overview of Seismic Performance	9
IV.	SELECTED RETROFIT OPTION	11
	A. Structural Strengthening.....	12
	B. Collateral Impacts	12
	C. Code-Required Upgrades	12
	D. Priority Upgrades	13
	E. Cost and Schedule	13
V.	COST-BENEFIT OF SELECTED RETROFIT OPTION	16
VI.	RISKS, ASSUMPTIONS, AND UNKNOWN INFORMATION	19
VII.	PROJECT SCOPE AND APPROACH.....	20
	A. Background	20
	B. Introduction to Building Codes and Seismic Risk.....	21
	C. Overview of Project Approach.....	22
	D. Sources of Information	24
	E. Requirements for Seismic Retrofits.....	25
	1. <i>Building Code Requirements</i>	25
	2. <i>Judicial Council Requirements</i>	26
	3. <i>Triggered Upgrades</i>	26
	F. Retrofit and Replacement Options Considered	27
	G. Basis of Retrofit Design	29
	H. Determination of Collateral Impacts	31
	I. Cost Estimation	32
	J. Seismic Risk Assessment	34
	K. Cost-Benefit Analysis.....	35
	L. Decision-Making Process.....	41
VIII.	REFERENCES	42
	APPENDIX A. ABBREVIATIONS AND GLOSSARY	
	APPENDIX B. SUMMARY SHEET	
	APPENDIX C. SEISMIC RETROFIT DRAWINGS	
	APPENDIX D. COST ESTIMATION PACKAGE	
	APPENDIX E. R+C PEER REVIEW LETTER	

DETAILED METHODOLOGY REPORT (issued separately)

- I. INTRODUCTION**
- II. MINIMUM CODE REQUIREMENTS FOR RETROFITS**
- III. BASIS OF SEISMIC RETROFIT DESIGN**
- IV. PROBABILISTIC SEISMIC RISK ASSESSMENT**
- V. COST-BENEFIT ANALYSIS**
- VI. REFERENCES**

Acknowledgements

The work presented in this report was performed by a consultant team comprising Arup, CO Architects, and MGAC between January and December of 2018. Funding for the feasibility study was provided by the Trial Court Facility Modification Advisory Committee. Judicial Council Facilities Services staff managed and directed the project, while Rutherford + Chekene, the structural peer reviewer retained by the Judicial Council, reviewed the work presented herein. Individuals within these organizations are acknowledged below.

Project Manager	Clifford Ham, Judicial Council Facilities Services
Primary Authors	Mike Mieler, Rob Smith, and Ibrahim Almufti, Arup
Primary Editors	Clifford Ham, Judicial Council Facilities Services Jesse Vernon and Tim Arioto, Arup
Engineers	Amie Nulman, Swami Krishnan, Lauren Biscombe, Kevin Chen, Saeed Fathali, Aysegul Gogus, Nicole Paul, and Terry Zhang, Arup
Architects	James Simeo, Antoinette Bunkley, Sona Aroush, Michael Johnson, Ed Martinez, and Sarah Holton, CO Architects
Cost Estimators	Rick Lloyd and Analyn Apan, MGAC
Peer Reviewers	William Holmes, Afshar Jalalian, and Marko Schotanus, Rutherford + Chekene
Contributors	Mike Courtney, Pella McCormick, Jagan Singh, and Zenaida Mananquil, Judicial Council Facilities Services Staff at the Superior Court of California, County of Alameda

Seismic Renovation Project Feasibility Report

George E. McDonald Hall of Justice (01-F1)

I. EXECUTIVE SUMMARY

This Project Feasibility Report presents findings and recommendations from the seismic renovation feasibility study of the George E. McDonald Hall of Justice. Based on these findings, which include results from a cost-benefit analysis, the Judicial Council Facilities Services staff has selected to retrofit the existing court building. Refer to Table 2 and Table 3 for general characteristics of the George E. McDonald Hall of Justice at the time of this study.

Facilities Services staff considered a total of three retrofit and two replacement options for the George E. McDonald Hall of Justice. The consultant team (Arup, CO Architects, and MGAC) estimated construction costs and duration for each option and compared these with the benefits of retrofitting or replacing the court building. The primary benefit of retrofitting or replacing the court building is reduced risk of seismic impacts relative to the existing court building, including reduced risk of collapse, fatalities, repair costs, and downtime. The team performed a cost-benefit analysis to compare the financial effectiveness of the five retrofit and replacement options for the George E. McDonald Hall of Justice.

Using outputs from this analysis, as well as additional considerations, the Judicial Council Facilities Services staff selected the priority upgrades retrofit option. This option involves seismic upgrades to structural and nonstructural components to achieve a level of seismic performance consistent with the Trial Court Facilities Act of 2002, nonstructural repairs made necessary by the retrofit, and triggered upgrades to accessibility and fire and life safety, as well as approved, unfunded facility modifications. The construction work is assumed to take place in phases by zone or floor while the court building remains open (as opposed to closing the facility and relocating court staff and functions to temporary space nearby during the retrofit). The priority upgrades retrofit option was selected because it provides the most benefit relative to its cost.

Table 1 summarizes the structural retrofit measures required for the George E. McDonald Hall of Justice as part of the priority upgrades retrofit. The retrofit will cost approximately \$18.4 million and take approximately 18 months to complete. These estimates including cost and schedule premiums for phasing the construction work to keep the court building open.

Table 1. Summary of Structural Retrofit Measures for the George E. McDonald Hall of Justice

Retrofit Measure	Description
Add new foundations	Add new micropile foundation under new braced frames.
Add new seismic braces	Add new structural bracing and columns (braced frames) around the perimeter of the building.
Strengthen facade connections	Install new anchors to strengthen the connection of concrete facade panels to the building.

II. INTRODUCTION

In January 2018, the Judicial Council of California Facilities Services engaged Arup, CO Architects, and MGAC (herein referred to as the consultant team) to perform a seismic renovation feasibility study for 26 court buildings in California. The study involved developing a conceptual seismic retrofit scheme for each building, determining the collateral impacts and associated construction costs of the retrofit schemes, and performing cost-benefit analyses to determine the most appropriate renovation strategy for each building.

This Seismic Renovation Feasibility Report presents findings and recommendations from the feasibility study of the George E. McDonald Hall of Justice. Bolded terms throughout this report are explained in more detail in the glossary in Appendix A.

A. Background and Context

The Trial Court Facilities Act of 2002 (Sen. Bill 1732; Stats. 2002, ch. 1082) initiated the transfer of responsibility for funding, operation, and ownership of court buildings from the counties to the Judicial Council and State of California. The act required most existing California court buildings to be seismically evaluated and assigned a risk level, with VII being the worst and I being the best. Facilities evaluated as Risk Level V or worse were ineligible for transfer to the state because they were deemed to have unacceptable seismic safety ratings. In total, 225 court buildings (comprising 300 **building segments**) were evaluated; 72 segments were rated Risk Level IV, while 228 were rated Risk Level V.

In 2015, the Judicial Council engaged Rutherford + Chekene (R+C) to develop a more refined **seismic risk rating** (SRR) for the 139 Risk Level V building segments that remained in the council's portfolio since the initial 2002 study. Using the Federal Emergency Management Agency's (FEMA) Hazus Advanced Engineering Building Module, R+C assigned an SRR to each building segment based on the relative **collapse probability** obtained from the 2003 seismic assessment of the structure (R+C 2017).

Informed by the SRRs, the Judicial Council Trial Court Facility Modification Advisory Committee authorized the California Superior Court Buildings Seismic Renovation Feasibility Studies project on August 28, 2017. The committee directed Facility Services staff to study 27 buildings that meet specific criteria, outlined further in Section VII.A (note that one court building was removed from the study due to lack of building drawings). Facilities Services engaged the consultant team in January 2018 to perform the study, which was completed in December 2018.

B. Summary of Project Approach

As part of the seismic renovation feasibility study, the consultant team reviewed structural and architectural drawings and previous seismic assessment reports to understand the critical seismic deficiencies and general layout of the court building. The team then conducted a site inspection and interviewed court staff to verify critical seismic deficiencies and document

Seismic Renovation Project Feasibility Report

George E. McDonald Hall of Justice (01-F1)

overall facility conditions before performing a supplemental seismic assessment to confirm previously identified deficiencies and identify new ones.

The consultant team then designed a conceptual retrofit scheme for the George E. McDonald Hall of Justice to address the critical seismic deficiencies identified from the supplemental seismic evaluation. The primary objective of the retrofit scheme is to reduce the seismic risk level of the court building from Risk Level V to IV, typically by strengthening existing **structural components**, adding new ones, or a combination of both.

The team then determined the **collateral impacts** of the retrofit scheme and identified code-required upgrades to accessibility and fire and life safety systems. Collateral impacts refer to repair work to **nonstructural components** (e.g., walls, ceilings, lighting, carpeting) made necessary by the retrofit. Appendix C provides the drawing package that describes the retrofit scheme, collateral impacts, and code-required upgrades. This scope of work is referred to as the **baseline retrofit option (Option 1)** because it represents the minimum required effort to achieve Risk Level IV seismic performance. Refer to Sections VII.E, VII.G, and VII.H for additional discussion of minimum retrofit requirements, the approach for designing the conceptual retrofit scheme, and determination of collateral impacts, respectively.

Because a seismic retrofit can be highly invasive, it provides an opportunity to make additional building repairs and upgrades for relatively little incremental cost. The Judicial Council Facilities Services staff asked the consultant team to include approved, unfunded facility modifications in addition to the minimum scope of work required in the baseline retrofit. Approved, unfunded facility modifications, referred to as **priority upgrades**, include building maintenance and systems upgrades that have been approved by the Judicial Council or Superior Court but do not have specific funding sources identified yet. Consequently, these facility modifications would be attractive candidates for inclusion in a seismic renovation. This option is referred to as the **priority upgrades retrofit option (Option 2)**.

Furthermore, because a seismic retrofit can be extremely costly, the consultant team also included a full renovation option and two replacement options for the purposes of benchmarking. While these three options did not involve any design work, they were included in the study as a reference point to identify situations where it may be more cost effective to either fully renovate or replace a court building. The **full renovation option (Option 3)** involves the same seismic retrofit as the baseline retrofit, plus full demolition and replacement of the building interior down to the structural skeleton and removal and replacement of the exterior wall and roof cladding. The first replacement option, referred to as the **replace to 2016 CBC option (Option 4)**, involves replacing the existing court building with a new facility that satisfies the requirements of the 2016 **California Building Code** (CBC; CBSC 2016a). The second replacement option, referred to as the **replace to beyond code option (Option 5)**, involves replacing the existing court building with a new facility that goes beyond the minimum requirements of the 2016 CBC to achieve more resilient seismic performance (e.g., reduced damage, repair costs, and downtime). Refer to Section VII.F for additional description of each retrofit and replacement option.

Seismic Renovation Project Feasibility Report George E. McDonald Hall of Justice (01-F1)

A total of five retrofit and replacement options were considered for the George E. McDonald Hall of Justice. The consultant team developed construction cost estimates and durations for each option (refer to Section VII.I) and compared these costs to the benefits of retrofitting or replacing the court building. The primary benefit of retrofitting or replacing the court building is reduced seismic risk relative to the existing court building, including reduced collapse probability, fatalities, repair costs, and downtime. Additional benefits stemming from retrofitting or replacing the court building (e.g., improved energy efficiency, accessibility, fire and life safety, security, employee productivity) were not quantified, though the costs of these upgrades were included in the cost-benefit analysis. The design team developed a risk model for each retrofit and replacement option to predict the reduction in seismic risk. Refer to Section VII.J for additional information about the risk assessment methodology.

The consultant team then performed cost-benefit analyses to compare the financial effectiveness of the five retrofit and replacement options for the George E. McDonald Hall of Justice. The benefit-cost ratio measures the benefits of an option relative to its cost and was the primary consideration in the Judicial Council Facilities Services staff's decision of which retrofit or replacement option to select. Refer to Section VII.K for additional discussion of the cost-benefit methodology.

The conceptual retrofit scheme for the George E. McDonald Hall of Justice was reviewed by R+C, the structural peer reviewer retained by the Judicial Council for this study, to confirm the validity and appropriateness of the proposed interventions. R+C also reviewed results from the seismic risk assessments and cost-benefit analyses. Refer to Appendix E for additional information about the peer review.

C. Report Organization

Section III of this report describes the general characteristics of the George E. McDonald Hall of Justice as it existed at the time of this study, including descriptions of critical seismic deficiencies and anticipated seismic performance.

Section IV summarizes each of the five retrofit and replacement options considered for the George E. McDonald Hall of Justice and describes the option selected by Judicial Council Facilities Services staff in more detail.

Section V presents results from the cost-benefit analysis of the selected option.

Section VI lists important project risks, assumptions, and unknown information for the George E. McDonald Hall of Justice and describes the potential impact each item could have on the conceptual retrofit scheme, its collateral impacts, and its construction costs and duration.

Section VII summarizes the scope and approach for the overall seismic renovation feasibility study.

Seismic Renovation Project Feasibility Report George E. McDonald Hall of Justice (01-F1)

Appendix A provides a list of abbreviations and glossary of terminology used throughout this report. Appendix B provides additional information about each of the five retrofit and replacement options. Appendix C provides structural and architectural drawings that show the conceptual retrofit scheme in detail. Appendix D provides a detailed cost breakdown for the selected renovation option. Appendix E provides a letter from R+C, structural peer reviewer to the Judicial Council, stating their professional opinion about overall appropriateness or validity of the conceptual retrofit scheme proposed by consultant team for the George E. McDonald Hall of Justice.

The detailed methodology report (Arup 2019), issued as a separate document, provides detailed information about the project approach and methodology, including minimum code requirements for seismic retrofits, basis of retrofit design, seismic risk assessment methodology, and cost-benefit analysis approach.

III. EXISTING BUILDING CHARACTERISTICS

This section describes the general characteristics of the George E. McDonald Hall of Justice as it existed at the time of this study, including descriptions of critical seismic deficiencies and anticipated performance in a strong earthquake.

The consultant team obtained information from a variety of sources, including documents and databases provided by Judicial Council staff (e.g., structural and architectural drawings, previous seismic evaluation reports, and facility condition assessments), notes and observations from site inspections and interviews with facilities staff at each court building, and results from **supplemental ASCE 41-13 Tier 1 evaluations and FEMA P-58 risk assessments** performed by the consultant team. Refer to Section VII for additional discussion of the sources of information considered in this study.

A. General Information

Table 2 provides general information about the court building, including location, gross floor area, number of daily visitors and staff, seismic hazard, and number of building segments. A building segment refers to a portion of the court building that may respond independently of other sections in an earthquake. Building segments can have very different properties (e.g., construction material and number of floors), and can be built at different times. However, from an operational perspective, they typically function together as a single facility.

Table 2. General Characteristics of the George E. McDonald Hall of Justice

Address	2233 Shoreline Dr., Alameda
Gross floor area	25,850ft ²
Number of daily visitors and staff*	245
Seismic hazard level[†]	1.12g
Liquefaction tier[‡]	Very High
Asbestos present**	No
Number of building segments	1
Replacement cost^{††}	\$30.4 million

* Based on average number of people passing through court building metal detectors (data provided by superior court staff)

† Based on the design short-period spectral response acceleration parameter, S_{xs} , for the BSE-1E Seismic Hazard Level specified in ASCE 41-13 (2014), which measures the intensity of ground shaking having a chance of occurrence no more than 20 percent in 50 years (or once every 225 years); larger values indicate higher seismic hazard

‡ Based on previous liquefaction studies by the United States Geological Survey and California Geological Survey (USGS 2000, USGS 2006, Jones et al. 2008); a site-specific geotechnical evaluation is required to verify liquefaction susceptibility at the court building

** Based on data provided by Judicial Council Facilities Services and superior court staff; presence and extent of asbestos to be confirmed in future studies

†† Based on the number of court departments at the existing court building and the median gross area per court department for California Superior Court buildings of similar scope constructed in the recent decade (data provided by Judicial Council staff to consultant team); refer to Section VII.F for additional information

Seismic Renovation Project Feasibility Report
George E. McDonald Hall of Justice (01-F1)

Table 3 provides additional information for each segment of the court building, including number of floors, construction year, **building type**, and SRR. The Judicial Council Facilities Services staff provided the consultant team with an SRR for each building segment. The SRR is based on the probability of collapse determined from FEMA’s Hazus Advanced Engineering Building Module, which adapts the standard Hazus methodology for estimating regional earthquake impacts for application to single buildings. Higher SRR values indicate higher collapse risk. For additional information about how the SRRs are computed, refer to the R+C report (2017).

Table 3. General Characteristics of Each Building Segment

	Building Segment
	George E. McDonald Hall of Justice (01-F1)
Gross floor area	25,850ft ²
Number of floors	2
Height	27ft
Year on original drawings*	1970
Building type†	S1
Seismic risk rating‡	6.2

* The year listed on the original, as-built drawings is roughly equivalent to the year the building segment was constructed, which can be used to determine the age of the building

† Refer to Appendix A for additional description of building type

‡ Indicates the degree of damage from an earthquake, with higher values representing higher collapse risk; see the R+C report (2017) for additional information.

Figure 1 provides a satellite image of the court building showing its overall configuration and construction. Figure 2 provides a satellite image of the court building overlaid with information about each building segment.

Seismic Renovation Project Feasibility Report
George E. McDonald Hall of Justice (01-F1)



Figure 1. Satellite Image Showing an Overview of the Court Building (Source: Google Earth)



Figure 2. Satellite Image Showing Each Building Segment (Source: USGS)

**Seismic Renovation Project Feasibility Report
George E. McDonald Hall of Justice (01-F1)**

B. Overview of Critical Seismic Deficiencies

Table 4 summarizes the critical seismic deficiencies identified for the George E. McDonald Hall of Justice, including a description of each deficiency and the risk it poses to the integrity of the structure and the safety of occupants. The consultant team performed a supplemental ASCE 41-13 Tier 1 evaluation of the court building to identify critical seismic deficiencies. The team also reviewed previous seismic assessment reports provided by Judicial Council Facility Services staff. Refer to Section VII.G for additional information about the overall seismic evaluation process and to the retrofit drawings in Appendix C for more specific descriptions of each seismic deficiency.

Table 4. List of Critical Seismic Deficiencies for the George E. McDonald Hall of Justice

Deficiency	Description	Risk
Inadequate connection of heavy cladding	Heavy cladding typically refers to stone or concrete facade panels. They are connected to the main structure with clips or similar connections. Older styles of construction did not consider the requirement to restrain the panels from lateral acceleration.	While unlikely to lead to building collapse, falling cladding could pose a significant risk to the safety of building occupants.
Inadequate stair detailing	The connection between the stairs and the main structure is not designed to accommodate relative movement.	The stairs could be damaged, potentially causing obstruction to the exit routes.
Inadequate stiffness of lateral system	The lateral system refers to the structural elements that provide resistance against earthquakes. This is as opposed to the gravity system, which supports vertical loads only. Some structural elements serve both purposes. Insufficient stiffness implies that the system is too flexible.	The structure could move excessively in an earthquake, causing damage to both the structure and its contents, which could pose a risk to the safety of building occupants.
Vertical discontinuity in lateral system	The lateral system, such as a wall or braced frame, does not continue uninterrupted from the roof to the foundation.	Excessive damage could occur below the interrupted element, where load cannot be transferred to the foundation. This could pose a significant risk to the safety of building occupants.
Pre-Northridge moment frame connections	A pre-Northridge moment frame connection refers to a type of steelwork beam-column connection that has potential design flaws. After the 1994 Northridge earthquake, the design code was changed to correct this.	Although no building has collapsed as a consequence of the pre-Northridge connections, there is sufficient concern in their performance to require mitigation.

C. Overview of Seismic Performance

The consultant team performed a FEMA P-58 risk assessment of the George E. McDonald Hall of Justice (as existed at the time of this study) to predict damage and related consequences in terms of fatalities, repair costs, and downtime under several earthquake

Seismic Renovation Project Feasibility Report
George E. McDonald Hall of Justice (01-F1)

intensity levels, ranging from small, frequent earthquakes to large, rare ones. Refer to Section VII.J for additional information about the risk assessment methodology.

The predicted losses at each earthquake intensity can be converted into annualized losses for the current existing court building. Table 5 provides information about the anticipated seismic performance of the George E. McDonald Hall of Justice in terms of annualized losses. Annualized losses represent the anticipated seismic losses in any given year, and typically would not be incurred every year (i.e., in most years, there are no earthquakes and therefore no losses; however, if a significant earthquake occurs, the losses that year will greatly exceed the annualized losses shown in Table 5). Over a long period of time, the actual losses incurred would approach the anticipated annualized losses. Though abstract in nature, annualized losses are useful because they capture in a single metric the magnitude of losses across a range of seismic intensities, thus enabling the risk reduction potential of each retrofit and replacement option to be compared more readily.

Table 5. Anticipated Seismic Performance of the Current Existing George E. McDonald Hall of Justice

Annual losses from fatalities*	\$2,276,000
Annual losses from repair costs	\$141,000
Annual losses from downtime	\$112,000

* Annual losses from fatalities are based on peak building populations and 90th percentile estimates of fatalities from the seismic risk assessment and, thus, likely represent an upper bound on annual losses from fatalities; refer to Section IV of the detailed methodology report (Arup 2019) for additional information about the risk assessment methodology and findings from a sensitivity study on building populations

Seismic Renovation Project Feasibility Report
George E. McDonald Hall of Justice (01-F1)

IV. SELECTED RETROFIT OPTION

Table 6 summarizes outputs from the cost-benefit analysis of each retrofit and replacement option for the George E. McDonald Hall of Justice. The benefit-cost ratio (BCR) measures the benefits of an option relative to its cost and was the primary consideration in the Judicial Council Facilities Services staff’s decision of which retrofit or replacement option to select. If the BCR exceeds one, then the benefits of the option exceed its costs, indicating it is effective from a purely financial perspective. The assumed **asset-life extension** is an important variable in the cost-benefit analysis, as it determines the length of time over which the benefits of retrofit or replacement can accrue. Refer to Section VII.K for additional discussion of the cost-benefit methodology and Appendix B for additional outputs from the cost-benefit analysis of each retrofit and replacement option.

Table 6. Summary of Outputs from Cost-Benefit Analysis of Five Retrofit and Replacement Options for the George E. McDonald Hall of Justice

	Baseline Retrofit (Option 1)*	Priority Upgrades Retrofit (Option 2)*	Full Renovation (Option 3)†	Replace to 2016 CBC (Option 4)‡	Replace to Beyond Code (Option 5)‡
Total construction costs	\$16.5 million	\$18.4 million	\$23.9 million	\$30.4 million	\$32.0 million
Construction duration	18 months	18 months	18 months	24 months	24 months
Benefit-cost ratio	1.36	1.61	1.45	1.27	1.23
Asset-life extension	15 years	25 years	40 years	50 years	50 years

* Assumes construction work is performed in phases (either by floors or zones of the buildings, outside normal court hours) to minimize its impact on operations; total construction costs include hard construction costs for all building segments and a cost premium for phased construction; refer to Appendix B for construction costs, duration, and benefit-cost ratio for unphased construction (i.e., court staff and functions moved to a temporary facility during retrofit); in this study, the cost premium for phased construction was typically less than the cost to rent and fit out temporary space

† Assumes court staff and functions moved to temporary facilities during renovation because of highly disruptive nature of a full renovation (i.e., phased construction not possible); total construction costs include hard construction costs for all building segments and the cost to rent and fit out temporary space

‡ Assumes replacement facility is constructed at a location different than the existing court building; total construction costs include hard construction costs but exclude land costs, demolition costs, or cost to rent and fit out temporary space

Using outputs from the cost-benefit analysis (in combination with additional considerations described in Section VII.L), the Judicial Council Facilities Services staff selected the priority upgrades retrofit option (Option 2). The priority upgrades retrofit option was selected for the following reasons:

1. It has the highest BCR, making it the best investment from a financial perspective (although the BCRs for other options are similar).
2. For a moderate increase in total construction costs over Option 1, it gains an extra 10 years in asset-life extension.

Seismic Renovation Project Feasibility Report

George E. McDonald Hall of Justice (01-F1)

That said, the existing court building has very high liquefaction risk. While the selected option does not involve replacing the court building, a new facility outside a liquefaction zone may be desirable to mitigate this risk.

The sections below describe the scope of the priority upgrades retrofit option.

A. Structural Strengthening

Table 7 summarizes the structural retrofit measures required for the George E. McDonald Hall of Justice to achieve Risk Level IV seismic performance. The table describes, at a high level, the scope of work required for each retrofit measure. Refer to Section VII.E for further discussion of minimum requirements for the seismic retrofit of court buildings in general, and Appendix C for more specific discussion of each retrofit measure for the George E. McDonald Hall of Justice, including structural drawings that show the proposed retrofit scheme in detail.

Table 7. Summary of Structural Retrofit Measures for the George E. McDonald Hall of Justice

Retrofit Measure	Description
Add new foundations	Add new micropile foundation under new braced frames.
Add new seismic braces	Add new structural bracing and columns (braced frames) around the perimeter of the building.
Strengthen facade connections	Install new anchors to strengthen the connection of concrete facade panels to the building.

B. Collateral Impacts

The retrofit measures described in Table 7 will affect spaces near the required structural interventions. Because structural components are typically hidden behind walls, ceilings, and other finishes, most retrofit measures will require repair work to nonstructural components, including doors, windows, ceilings, carpeting, lighting, and any mechanical, electrical, plumbing, audiovisual, IT, and security systems impacted by the structural intervention.

Refer to Section VII.H for additional discussion of the approach used by the consultant team to determine collateral impacts, and the architectural drawings in Appendix C for further detail on specific collateral impacts. While the exact impacts cannot be determined until a detailed retrofit design is commissioned and a timetable for construction is established, the conceptual retrofit scheme and its collateral impacts provide a sufficient basis for understanding the feasibility and approximate total cost of retrofitting the building.

C. Code-Required Upgrades

The proposed seismic retrofit scheme triggers code-required upgrades to accessibility and fire and life safety. In general, accessibility upgrades are required for the primary entrance and any facilities serving the area, including toilets, drinking fountains, public phones, and signs. In addition, accessibility upgrades are required for the path of travel from the primary entrance to specific areas of structural strengthening, including upgrades to any facilities

Seismic Renovation Project Feasibility Report

George E. McDonald Hall of Justice (01-F1)

serving the areas of alteration. Refer to the architectural drawings in Appendix C for additional detail on code-required accessibility upgrades.

In terms of fire and life safety, the following upgrades are required per the 2016 California Fire Code (CBSC 2016b):

- Provide emergency responder radio coverage
- Provide fire alarm system, with both automatic and manual fire alarm systems in Group I-3 occupancy

Ultimately, fire and life safety upgrades are at the discretion of the State Fire Marshal. For this study, the consultant team assumed that all required upgrades specified in the 2016 California Fire Code would be triggered by a seismic retrofit. However, if the existing court building does not currently have a fire sprinkler system, the seismic retrofit design does not include installing one, though the State Fire Marshal may require it. In aggregate, these assumptions are reasonably conservative and result in upper-bound estimates of fire and life safety construction costs.

D. Priority Upgrades

The following list of priority upgrades were provided to the consultant team by staff at the George E. McDonald Hall of Justice. Priority upgrades refer to approved, unfunded facility modifications and do not include all possible maintenance needs at the court building.

- Replace air handler unit

E. Cost and Schedule

Table 8 summarizes construction costs and duration for the priority upgrades retrofit. The numbers in the table assume the retrofit work is performed in phases (either by floors or zones of the buildings, outside normal court hours) to minimize its impact on operations. This results in additional construction costs and duration.

The consultant team also determined the costs of unphased construction in which court staff and functions would be relocated to temporary facilities for the duration of the retrofit work. In general, this results in shorter construction duration but also potentially significant costs to rent and fit out temporary space, assumed to be 75 percent of the current court-occupied area. Appendixes B and D provide a full cost breakdown of phased and unphased construction for the priority upgrades retrofit option, and Section VII.I describes the cost-estimation approach in more detail.

Seismic Renovation Project Feasibility Report
George E. McDonald Hall of Justice (01-F1)

Table 8. Comparative Construction Cost Estimates and Duration

	Priority Upgrades Retrofit (Option 2)*	Replace to 2016 CBC (Option 4) †
Construction costs	\$15.3 million	\$30.4 million
Cost to phase construction	\$3.1 million	N/A
Total construction costs	\$18.4 million	\$30.4 million
Area	25,850ft ²	36,900ft ²
Cost per square foot	\$711	\$825
Construction duration	18 months	24 months

* Assumes construction work is performed in phases (either by floors or zones of the buildings, outside normal court hours) to minimize its impact on operations; total construction costs include hard construction costs for all building segments and a cost premium for phased construction; refer to Appendix B for construction costs, duration, and benefit-cost ratio for unphased construction (i.e., court staff and functions moved to a temporary facility during retrofit); in this study, the cost premium for phased construction was typically less than the cost to rent and fit out temporary space

† Assumes replacement facility is constructed at a location different than the existing court building; total construction costs include hard construction costs but exclude land costs, demolition costs, or cost to rent and fit out temporary space

Table 8 also provides the costs to replace the current existing court building with a new multipurpose court facility that satisfies the requirements of the 2016 CBC and the 2011 Judicial Council California Trial Court Facilities Standards. This replacement building is provided for the purposes of comparison should the Judicial Council be interested in replacing rather than retrofitting the court building. The replacement building would be approximately 36,900 square feet in program gross area, and accommodate 3 court departments, with supporting court administration, secure holding spaces, and separate circulation paths for public, staff, and in-custody participants. The existing current court building has 25,850 square feet of total area.

The replacement court building would provide the Superior Court and public with a fully functional, secure, durable, and energy efficient court facility that could accommodate any case-type calendar including criminal cases and jury trials. Consistent with Judicial Council general practice for new court buildings, the replacement court building would contain only Superior Court functions; it excludes area currently used by county agencies in the existing George E. McDonald Hall of Justice. The replacement option does not include a staff/public parking structure. The location of the replacement court building would be in general vicinity of the existing court building in Alameda County. Determination of a replacement building site and design of the new facility are beyond the scope of this study.

The consultant team recommends designing any new replacement building to exceed the minimum requirements of the 2016 CBC to achieve more resilient seismic performance. The Resilience-based Earthquake Design Initiative (REDi) framework outlines criteria for resuming building operations quickly after an earthquake (Arup 2013). While a building

Seismic Renovation Project Feasibility Report
George E. McDonald Hall of Justice (01-F1)

designed in accordance with REDi criteria has a similar level of seismic safety (i.e., collapse probability) as one designed to the 2016 CBC, a REDi building is explicitly designed to recover functionality within a specified timeframe after a large earthquake (e.g., 30 days for REDi Gold performance) and cost marginally more than a code-compliant one (typically less than 5 percent more). Code-compliant buildings, on the other hand, are not designed to minimize the type of earthquake-induced damage that can result in significant repair costs and downtime.

V. COST-BENEFIT OF SELECTED RETROFIT OPTION

As described in previous sections, the selected retrofit option for the George E. McDonald Hall of Justice reduces the risk of collapse, fatalities, repair costs, and downtime in future earthquakes. Table 9 compares the annual losses for the existing court building and the selected retrofit option.

The priority upgrades retrofit option was selected for the following reasons:

1. It has the highest BCR, making it the best investment from a financial perspective (although the BCRs for other options are similar).
2. For a moderate increase in total construction costs over Option 1, it gains an extra 10 years in asset-life extension.

That said, the existing court building has very high liquefaction risk. While the selected option does not involve replacing the court building, a new facility outside a liquefaction zone may be desirable to mitigate this risk.

Table 9. Comparison of Seismic Risk Between the Existing Court Building and Selected Retrofit Option

	Existing Court Building	Priority Upgrades Retrofit (Option 2)
Annual losses from fatalities*	\$2,276,000	\$115,000
Annual losses from repair costs	\$141,000	\$29,000
Annual losses from downtime†	\$112,000	\$73,000
Total construction cost	n/a	\$18.4 million
Benefit-cost ratio	n/a	1.61
Asset-life extension	n/a	25 years

* Annual losses from fatalities are based on peak building populations and 90th percentile estimates of fatalities from the seismic risk assessment and, thus, likely represent an upper bound on annual losses from fatalities; refer to Section IV of the detailed methodology report (Arup 2019) for additional information about the risk assessment methodology and findings from a sensitivity study on building populations

† The primary intent of the retrofit is to reduce the risk of collapse and fatalities. While some reduction in downtime may be expected, the conceptual retrofit scheme does not include specific measures to reduce downtime. Therefore, downtime losses typically do not decrease significantly as a result of the retrofit.

Table 10 compares benefit-cost ratios (BCRs) of the selected retrofit or replacement options across the portfolio of 26 court buildings included in this study. Court buildings are sorted from highest BCR to lowest. Court buildings with the largest BCRs represent the best retrofit or replacement investments, but additional factors (e.g., total construction cost, importance of the existing court building to continuing Superior Court operations) need to be considered in developing judicial branch-wide renovation strategies or priorities. The total estimated construction cost associated with retrofitting or replacing all 26 court buildings is \$2.3 billion.

Seismic Renovation Project Feasibility Report
George E. McDonald Hall of Justice (01-F1)

Table 10. Comparison of Construction Costs and Benefit-Cost Ratios for 26 Court Buildings (George E. McDonald Hall of Justice highlighted)

ID	Name	Court Departments	Selected Option *	Total Construction Cost (millions)	Benefit-Cost Ratio	Asset-Life Extension (years)
13-A1	Imperial County Courthouse	7	4	\$48.9	6.78	50
17-B1	Clearlake Branch Courthouse	1	4	\$8.0	2.50	50
19-O1	El Monte Courthouse	6	4	\$41.0	2.28	50
19-X1	West Covina Courthouse	11	1	\$23.6	2.26	15
07-F1	George D. Carroll Courthouse	8	4	\$82.2	1.98	50
19-AD1	Santa Clarita Courthouse	3	1	\$12.1	1.92	15
44-A1	Santa Cruz Courthouse	7	4	\$49.8	1.91	50
19-W2	Pomona Courthouse North	7	4	\$47.9	1.72	50
28-B1	Napa Courthouse	4	4	\$32.6	1.63	50
01-F1	George E. McDonald Hall of Justice	3	2	\$18.4	1.61	25
19-AK1	Norwalk Courthouse	20	1	\$45.9	1.07	15
19-H1	Glendale Courthouse	8	2	\$44.0	1.07	25
30-A1	Central Justice Center	65	2	\$196.5	0.77	25
30-C1 C2	North Justice Center	18	1	\$75.4	0.77	15
19-G1	Burbank Courthouse	7	4	\$50.4	0.76	50
10-A1	Fresno County Courthouse	28	1	\$103.0	0.65	15
30-B1	Lamoreaux Justice Center	29	2	\$106.7	0.63	25
19-K1	Stanley Mosk Courthouse	100	1	\$461.3	0.58	15
19-AO1	Whittier Courthouse	7	2	\$54.3	0.57	25
19-AQ1	Beverly Hills Courthouse	6	5	\$47.3	0.55	50
19-J1 J2	Pasadena Courthouse	19	5	\$165.3	0.52	50
07-A2	Wakefield Taylor Courthouse	12	2	\$64.6	0.47	25
19-AX2	Van Nuys Courthouse West	23	2	\$160.4	0.46	25
19-AP1	Santa Monica Courthouse	17	1	\$50.5	0.43	15
19-L1	Clara Shortridge Foltz Criminal Justice Center	60	2	\$300.2	0.26	25

**Seismic Renovation Project Feasibility Report
George E. McDonald Hall of Justice (01-F1)**

ID	Name	Court Departments	Selected Option *	Total Construction Cost (millions)	Benefit-Cost Ratio	Asset-Life Extension (years)
19-I1	Alhambra Courthouse	9	1	\$42.3	0.19	15

* Option 1: Baseline Retrofit
 Option 2: Priority Upgrades Retrofit
 Option 3: Full Renovation
 Option 4: Replace to 2016 CBC
 Option 5: Replace to Beyond Code

As noted in Table 9, annual losses from fatalities are based on peak building populations and 90th percentile estimates of fatalities from the seismic risk assessment, likely resulting in an upper bound on annual losses from fatalities. In contrast, annual losses from repair costs and downtime are based on mean estimates of repair costs and downtime, respectively, which effectively translates into a higher weighting for losses stemming from fatalities. This higher weighting is consistent with the primary focus of the study: improving the seismic safety of the current existing court building. However, it inflates the BCR values presented in Table 10 relative to if an equivalent continuous occupancy (ECO) population were assumed for each court building. An ECO population accounts for the fact that the peak population persists for only a short period of time in a building over a typical year, so there is only a small probability that an earthquake would occur when the building is fully occupied. As a result, because the BCRs in Table 10 emphasize fatalities, they should not be considered absolute. Additional limitations in the BCR values are described in Section VII.K.

Section IV of the detailed methodology report (Arup 2019) presents findings from a sensitivity study of the BCRs to the assumed building population to investigate whether the higher weighting given to fatalities might also change the relative rankings of the BCRs for each of the five retrofit or replacement options considered for the George E. McDonald Hall of Justice. In summary, changing the building population from peak to ECO, which typically reduces the number of fatalities reported by a factor of 4, does not significantly change the relative order of the retrofit and replacement options. While the BCRs were not the only factor in the decision-making process, the sensitivity study demonstrates that changes to the assumed building population do not impact the selected option for the George E. McDonald Hall of Justice.

Seismic Renovation Project Feasibility Report
George E. McDonald Hall of Justice (01-F1)

VI. RISKS, ASSUMPTIONS, AND UNKNOWN INFORMATION

Table 11 summarizes important project risks, assumptions, and unknown information for the George E. McDonald Hall of Justice and describes the potential impact each item could have on the conceptual retrofit scheme, its collateral impacts, and its construction costs and duration. These items need to be considered in later phases of the project if a more detailed design of the seismic retrofit scheme is commissioned.

Table 11. Summary of Important Project Risks, Assumptions, and Unknown Information for the Seismic Retrofit of the George E. McDonald Hall of Justice

Category	Description	Impact
Analysis scope	The conceptual retrofit scheme described in this report is based on limited information and seismic analysis. For example, no materials testing, geotechnical studies, or intrusive testing have been performed. An analytical model of the building was not developed. Furthermore, design optimization has not been carried out (i.e., minimizing collateral impacts and construction costs). While this is appropriate for budgetary checking, a more thorough engineering study would need to be performed prior to construction.	A more thorough study could impact construction costs and collateral impacts.
Sea level rise	The court building is vulnerable to sea level rise and is projected to be in the 100-year-storm floodplain in 100 years, assuming 5.7 feet of sea level rise over the next 100 years. The conceptual retrofit scheme described in this report does not mitigate the potential impacts of sea level rise. Additional environmental studies would be required to understand the risks associated with climate change.	Depending on the findings from the environmental studies, it could impact construction costs and collateral impacts.
Seismic braces	The conceptual retrofit scheme assumes that new seismic braces are installed from the interior to obtain an upper bound estimate on cost. However, it may be possible to install the braces from the exterior. Further investigation is required as part of detailed retrofit design.	Installing braces from the exterior (instead of the interior) could reduce construction costs and collateral impacts.
Liquefaction	The court building has very high liquefaction risk. The conceptual retrofit scheme does not mitigate this risk. To determine the extent of foundation retrofit required, a site-specific geotechnical investigation is required.	If foundation strengthening is required, it could impact construction costs and collateral impacts.

VII. PROJECT SCOPE AND APPROACH

In January 2018, the Judicial Council of California Facilities Services engaged Arup, CO Architects, and MGAC (herein referred to as the consultant team) to perform a seismic renovation feasibility study for 26 court buildings in California. The study involved developing a conceptual seismic retrofit scheme for each building, determining the collateral impacts and associated construction costs of the retrofit schemes, and performing cost-benefit analyses to determine the most appropriate renovation strategy for each building. The following sections summarize the methodology and approach used by the consultant team to conduct the renovation feasibility study, including Judicial Council goals, definitions of key concepts, project scope and workflow, and assumptions and limitations of the study.

A. Background

The Trial Court Facilities Act of 2002 (Sen. Bill 1732; Stats. 2002, ch. 1082) initiated the transfer of responsibility for funding, operation, and ownership of court buildings from the counties to the Judicial Council and State of California. The act required most existing facilities to be seismically evaluated and assigned a risk level, with VII being the worst and I being the best. Facilities evaluated as Risk Level V or worse were ineligible for transfer to the state because they were deemed to have unacceptable seismic safety ratings. In total, 225 court buildings (comprising 300 building segments, see Appendix A for the definition of a segment) were evaluated; 72 segments were rated Risk Level IV, while 228 were rated Risk Level V.

In 2015, the Judicial Council engaged Rutherford + Chekene (R+C) to develop a more refined seismic risk rating (SRR) for the 139 Risk Level V building segments that remained in the council's portfolio since the initial 2002 study. Using FEMA's Hazus Advanced Engineering Building Module, R+C assigned an SRR to each building segment based on the relative probability of collapse obtained from the 2003 seismic assessment of the structure (R+C 2017).

Informed by the SRRs, the Judicial Council Trial Court Facility Modification Advisory Committee authorized the California Superior Court Buildings Seismic Renovation Feasibility Studies project on August 28, 2017. The committee directed Facility Services staff to study 27 buildings that meet specific criteria. For a court building to be a candidate for the renovation feasibility study, it must meet all the following criteria:

- It has a Very High or High SRR.
- It is not being replaced by an active new courthouse construction project.
- It is not subject to a memorandum of understanding restricting transfer because of historic building designation.
- It is owned by the Judicial Council or has a transfer of title pending, or the court occupies more than 80 percent of a county owned building.

Seismic Renovation Project Feasibility Report

George E. McDonald Hall of Justice (01-F1)

- The investment would extend its useful life for long-term service to the public.

One court building was removed during the study due to a lack of structural and architectural drawings. The 26 court buildings studied have a total area of approximately five million gross square feet and comprise 43 building segments. Figure 3 shows the location and area of each court building. Blue pins indicate court buildings smaller than 100,000 square feet, orange indicates between 100,000 and 180,000 square feet, and purple indicates more than 180,000 square feet.

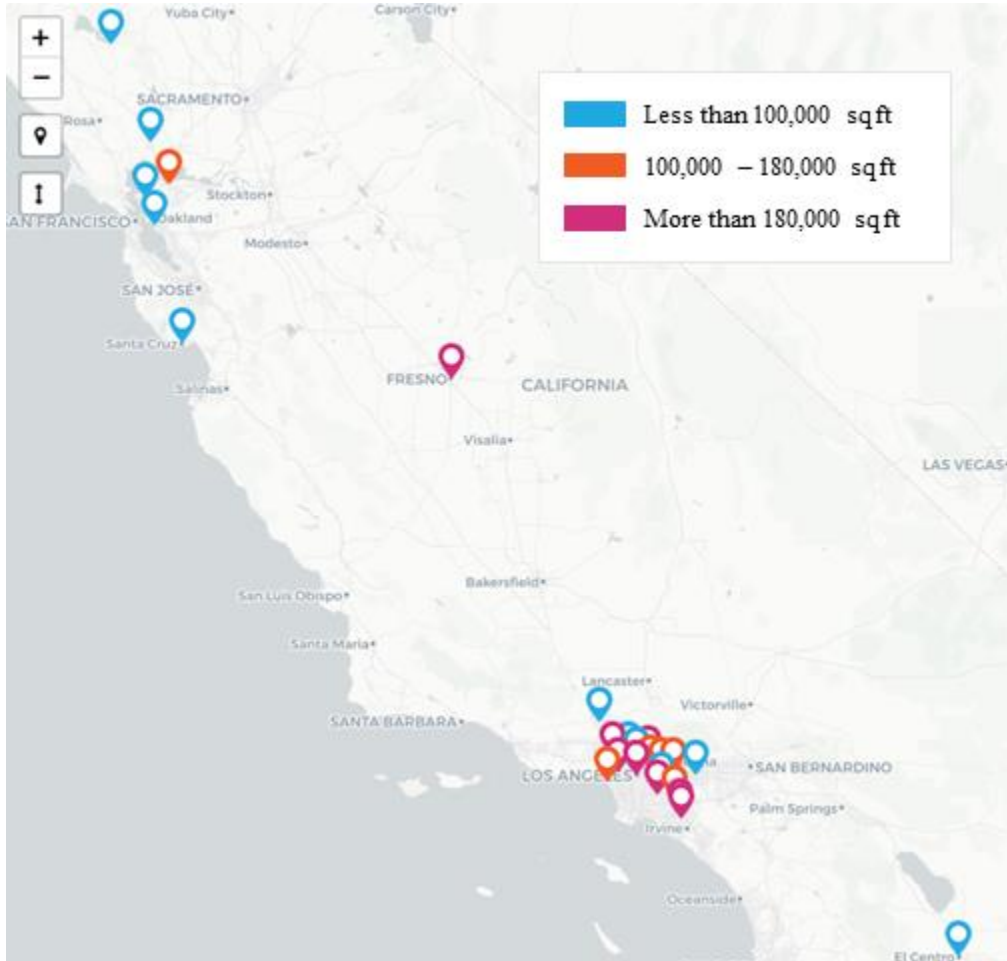

Figure 3. The 26 Court Buildings Assessed in This Seismic Renovation Feasibility Study

B. Introduction to Building Codes and Seismic Risk

No building is fully earthquake proof. Even structures designed to modern building codes are expected to be damaged in a major earthquake, resulting in potentially significant financial losses and downtime. However, major earthquakes occur infrequently. In more frequent but less intense seismic events, newly constructed buildings are expected to experience minor damage, if any. This is a consequence of the overall intent of modern building codes, which focus on protecting lives while attempting to minimize initial construction costs.

In California, building codes and standards require new structures to achieve **life safety performance** in the **design basis earthquake**, which refers to a level of ground shaking defined within the standards. Life safety performance refers to a post-earthquake damage state in which significant damage to the structure has occurred, but the overall risk of life-threatening injury from this damage is expected to be low (ASCE 2014). However, the financial losses and downtime stemming from this damage could be significant, and ultimately the building may need to be demolished. If more intense earthquake shaking were to occur than defined within the standards, the risk of life-threatening injury would increase. For buildings that support essential post-earthquake functions like hospitals and fire stations, or are places of assembly like stadiums and court buildings, the building code requires more stringent seismic performance. Consequently, newly constructed court buildings are expected to achieve better than life safety performance in the design basis earthquake.

In general, engineers expect older buildings to perform worse than newly constructed ones, primarily because they were designed using previous versions of the building code and constructed using outdated materials and practices. Over the past 50 years, engineers have made incremental improvements to building codes and construction practices as they gain additional insight into how buildings perform following actual earthquakes worldwide. A large number of court buildings in California were built before modern seismic design codes were in place, resulting in a collectively significant seismic risk. To address these risks, many jurisdictions in California have retrofitted some of their most vulnerable buildings, including both unreinforced masonry and soft-story buildings. Typically, these retrofit programs have addressed only the most critical deficiencies in older structures, which reduces the risk of life-threatening injury but often does little to reduce the types of damage that lead to significant financial losses and downtime.

In 2003, the American Society of Civil Engineers (ASCE) published the first standard for seismic evaluation of existing buildings (ASCE 31-03), followed in 2007 by the first standard for seismic retrofit of existing buildings (ASCE 41-06). In 2014, ASCE merged both standards and published a major revision (ASCE 41-13), which was then updated in 2017 (ASCE 41-17). Unlike modern building codes, ASCE 41 does not mandate minimum performance objectives for seismic retrofits. However, engineers typically target the basic performance objective for existing buildings (BPOE), which accepts a higher risk of collapse and life-threatening injury than is permitted in modern building codes for new building. This less stringent performance objective reflects the technical challenges and high costs associated with retrofitting older buildings. Section VII.G provides additional information about ASCE 41-13.

C. Overview of Project Approach

The 2003 seismic evaluation of court buildings (and subsequent follow-on study by R+C in 2017) revealed that a large number are seismically vulnerable and will likely perform poorly in future earthquakes. The Judicial Council engaged the consultant team to conduct seismic

Seismic Renovation Project Feasibility Report

George E. McDonald Hall of Justice (01-F1)

renovation feasibility studies for 26 high-risk court buildings. The goals of this study are as follows:

- Examine the feasibility of retrofitting each court building to reduce its seismic risk level from V to IV, including development of a conceptual retrofit scheme, determination of collateral impacts and additional upgrades required by the building code, and estimation of construction costs and duration
- Perform cost-benefit analysis to compare the financial effectiveness of a retrofit scheme or replacement for each court building
- Informed by feasibility and cost-benefit analyses, select a retrofit or replacement option and develop a project feasibility report for each court building
- Describe the renovation in sufficient detail that readers unfamiliar with the subject building or construction could reasonably understand the likely scope, complexity, cost, and duration of the proposed renovation

To achieve these project goals, the consultant team performed the following tasks for each court building:

1. Reviewed structural and architectural drawings, previous seismic assessment reports, and other documents provided to the consultant team by the Judicial Council to understand the critical seismic deficiencies and general layout of each court building. Section VII.D describes this task in more detail.
2. Conducted site inspections and interviewed court staff to verify critical seismic deficiencies and document overall facility conditions, including changes in floor plan (that are not shown in the drawings), accessibility, and fire and life safety deficiencies. A full conditions assessment was not performed as part of this task. Furthermore, the site inspections did not include any destructive testing to verify material properties or involve removing finishes to confirm structural properties. Interviews were used to identify building upgrades that had previously been approved but were unfunded. Such upgrades therefore did not include all possible maintenance needs, but only approved, unfunded facility modifications, known in this report as priority upgrades.
3. Performed a seismic assessment to identify critical seismic deficiencies for all building segments. While a seismic evaluation was conducted in 2003, improvements to the assessment procedures in ASCE 41 have been made since then. Furthermore, changes had also been made to the seismic hazard documented in the building codes. Consequently, the consultant team, with approval from Judicial Council Facilities Services staff, performed a supplemental seismic assessment to confirm previously identified deficiencies and identify new ones. A geotechnical investigation to verify soil properties was not performed as part of this process. Section VII.G describes this task in more detail.

4. Designed a conceptual seismic retrofit scheme that addresses the deficiencies identified in the previous task and achieves Risk Level IV seismic performance for all building segments. Refer to Section VII.E for minimum requirements for the seismic retrofit of court buildings. The retrofit scheme was developed to a level of detail sufficient for cost estimation and feasibility verification only; consequently, it is not a definitive design and should not be used for the purposes of determining an exact construction budget. Section VII.G describes this task in more detail.
5. Evaluated the collateral impacts of the proposed seismic retrofit scheme, including nonstructural repairs made necessary by the retrofit and triggered upgrades to accessibility and fire and life safety systems required by the building code. Section VII.H describes this task in more detail.
6. Estimated construction costs and duration for the proposed seismic retrofit scheme and its collateral impacts. Section VII.I describes this task in more detail.
7. Conducted a seismic risk assessment of both the court building as it currently exists and the proposed retrofit scheme to quantify the reduction in likelihood of fatalities, repair costs, and downtime achieved by the retrofit across a range of earthquake intensities. A risk assessment of a generic replacement building was also conducted to enable comparison of the retrofit to a newly constructed facility. Section VII.J describes this task in more detail.
8. Using construction cost estimates and results from the seismic risk assessment as inputs, performed a cost-benefit analysis to compare the financial effectiveness of retrofitting versus replacing each court building. Section VII.K describes this task in more detail.

Judicial Council Facilities Services staff then selected the retrofit or replacement option using results from the cost-benefit analysis to inform the decision-making process. Section VII.L describes this task in more detail.

D. Sources of Information

The consultant team considered many sources of information in performing the tasks summarized in Section VII.C. The Judicial Council provided the following documents to the consultant team:

- Original architectural, structural, or as-built drawings for each court building
- Drawings of previous modifications, alterations, or retrofits for each court building
- Seismic assessment reports from 2003 for each court building (based on ASCE 31-03 Tier 1 or 2 procedures)
- Facility conditions report for each court building

Seismic Renovation Project Feasibility Report

George E. McDonald Hall of Justice (01-F1)

- A database containing information about the portfolio of court buildings, including ownership, gross area, area occupied by courts, number of floors, age, building type, SRR, number of courtrooms, and presence of asbestos

The quality and availability of information available varies from one court building to the next. For locations with missing or illegible drawings, or incomplete seismic assessment reports, the consultant team made appropriate assumptions about structural details, material strengths, location of structural components, and other missing information. These assumptions are clearly documented in Section VI for George E. McDonald Hall of Justice.

In addition to the documents listed above, the consultant team also compiled a large amount of information from additional sources, including notes from interviews with court staff, photos from site inspections, and responses to online questionnaires sent to court staff.

E. Requirements for Seismic Retrofits

To inform the design of the conceptual retrofit schemes, the consultant team reviewed the regulatory framework applicable to the Judicial Council to establish minimum requirements for the proposed retrofits. The purpose of this review was to determine:

- Minimum requirements for seismic retrofits from the building code;
- Minimum requirements for seismic retrofits from the Judicial Council; and
- Required upgrades, if any, to accessibility, life safety, and building systems (e.g., electrical, mechanical) triggered by the seismic retrofit.

The requirements are summarized below and described in more detail in Section II of the detailed methodology report (Arup 2019).

1. Building Code Requirements

The governing code for renovations to existing facilities is the 2016 **California Existing Building Code (CEBC)**. For renovation projects whose construction costs exceed 25 percent of the replacement value of the building, the seismic performance requirements of Section 317 of the 2016 CEBC apply. Based on previous experience, the consultant team anticipated that a typical seismic retrofit of a court building would exceed this threshold and, therefore, require compliance with Section 317. After designing each retrofit and estimating its cost, the consultant team verified that the 25 percent cost threshold is triggered for all court buildings. Consequently, the seismic retrofit of a court building must satisfy the two-tiered performance objective in Table 317.5 of the 2016 CEBC (CBSC 2016c):

- Level 1: In the 20 percent in 50-year seismic event (i.e., the 225-year earthquake), life safety performance for both structural and nonstructural components

- Level 2: In the 5 percent in 50-year seismic event (i.e., the 975-year earthquake), **collapse prevention performance** for the structure, while the performance of nonstructural components is not considered

This performance objective is equivalent to the BPOE for Risk Category II structures specified in ASCE 41-13. While court buildings are classified as Risk Category III structures in the 2016 CBC, which governs how new buildings are designed and constructed, the two-tiered performance objective specified in Table 317.5 of the 2016 CEBC translates to a Risk Category II classification per ASCE 41-13. The risk categories in ASCE 41-13 and the 2016 CBC, which provide the basis for applying earthquake provisions based on a building's use or occupancy, are distinct from Judicial Council risk levels, which measure the damageability of a court building in an earthquake.

2. Judicial Council Requirements

The Judicial Council requirements specify that retrofitted buildings must meet a Risk Level IV performance at a minimum. Language in the Trial Court Facilities Act of 2002 reinforces this, and further definitions are provided in documents written by California Department of General Services (2009). While the technical definitions for seismic risk levels in these documents are not directly compatible with more recent standards (e.g., ASCE 41-13), the consultant team determined that Risk Level IV is equivalent to BPOE for Risk Category II structures, and hence the Judicial Council requirements are consistent with the CEBC requirements for seismic performance.

3. Triggered Upgrades

The CEBC sets out criteria for when a seismic retrofit triggers upgrades to both accessibility and fire and life safety systems. Accessibility upgrades are required for the primary entrance and any facilities serving the area (e.g., toilets, drinking fountains, public phones, signs). In addition, accessibility upgrades are required for the path of travel from the primary entrance to specific areas of alteration, including upgrades to any facilities serving the areas of alteration. Furthermore, a seismic retrofit will also trigger fire and life safety upgrades per the 2016 California Fire Code, including emergency responder radio coverage, standpipes in high-rise buildings, and fire alarm systems (CBSC 2016b). Ultimately, fire and life safety upgrades are at the discretion of the State Fire Marshal. For the purposes of this study, the consultant team assumed that all required upgrades specified in the 2016 California Fire Code would be triggered by a seismic retrofit. However, if the existing court building does not currently have a fire sprinkler system, the seismic retrofit design does not include installing one because it is not required by the code, though the State Fire Marshal may require it. In aggregate, these assumptions are reasonably conservative and result in upper-bound estimates of fire and life safety construction costs.

F. Retrofit and Replacement Options Considered

Based on the minimum retrofit requirements summarized in Section VII.E, the consultant team, with input from Facilities Services, established several retrofit and replacement options to be considered for each court building. The five options — three retrofit options and two replacement options — are summarized in the text below and in Table 12.

1. **Baseline retrofit:** includes seismic upgrades to structural and nonstructural components (e.g., stairs, elevators, ceilings, lights, partitions) to achieve Risk Level IV performance (i.e., ASCE 41-13 BPOE for Risk Category II structures), nonstructural repairs made necessary by the retrofit, and triggered upgrades to accessibility and fire and life safety systems. This option represents the minimum level of effort and expenditure to mitigate the seismic risk at each court building.
2. **Priority upgrades retrofit:** includes the same upgrades as Option 1, plus any priority upgrades, which refer to approved but unfunded facility modifications. This option was included in the study because seismic retrofits often provide an opportunity to upgrade outdated or deficient building systems (which would be highly disruptive) at relatively little additional cost.
3. **Full renovation:** includes the same seismic upgrades to structural components as Option 1, plus full demolition and replacement of the building interior down to the structural skeleton, including removal of the exterior wall and roof cladding. Consequently, the necessary nonstructural seismic upgrades, nonstructural repairs, triggered upgrades to accessibility and fire and life safety systems, and priority upgrades are not specifically considered in this option, since a new building interior will incorporate these features. This option was included because some retrofits are highly invasive, so that a complete interior and exterior renovation would provide direct access for improvement of the structural system, and hence might not entail much additional cost compared to retrofit option 1 or 2. Design of the fully renovated interior and exterior is beyond the scope of this study.
4. **Replace to 2016 CBC:** involves replacing the existing court building with a new facility that satisfies the requirements of the 2016 CBC, sized in accordance with the Judicial Council California Trial Court Facilities Standards (2011). Refer to Section IV for assumed parameters for the replacement building for the George E. McDonald Hall of Justice. The size of a replacement building was determined by using the number of court departments at the existing court building and the median gross area per court department (for California Superior Court buildings of similar scope constructed in the recent decade). In addition, a replacement court building would contain only Superior Court functions, resulting in a replacement building size that is in general alignment with the Judicial Council Standards for new court buildings, but may be substantially smaller or larger than the existing building. This replacement option was included for the purposes of benchmarking because some retrofit schemes are so disruptive and costly that it might be more cost effective to

replace the court building with a new facility. The construction costs for replacement buildings are derived from the Judicial Council cost-model database of construction costs for California Superior Court buildings of similar scope and location constructed in the recent decade. Design of the new court facility is beyond the scope of this study.

5. **Replace to beyond code:** involves replacing the existing court building with a new facility that achieves a seismic performance level exceeding the minimum requirements of the 2016 CBC, sized in accordance with the Judicial Council California Trial Court Facilities Standards (2011). This facility is expected to be more resilient — experience less damage and downtime in future earthquakes — than a code-compliant building. The Resilience-based Earthquake Design Initiative (REDi) framework outlines criteria for resuming building operations quickly after an earthquake (Arup 2013). While a building designed in accordance with REDi criteria has a similar level of seismic safety (i.e., collapse probability) as one designed to the 2016 CBC, a REDi building is explicitly designed to recover functionality within a specified timeframe after a large earthquake (e.g., 30 days for REDi Gold performance). Code-compliant buildings, on the other hand, are not designed to minimize the type of earthquake-induced damage that can result in significant repair costs and downtime. This option was included because it is often only marginally more expensive (i.e., less than 5 percent premium) to construct a more resilient building.

The five retrofit and replacement options were included in the study to provide the Judicial Council with the full range of mitigation options for each court building. Within the portfolio of 26 high- and very-high-risk buildings in this study, some required relatively simple retrofit schemes, while others were more invasive and, from a cost perspective, were potential candidates for replacement rather than retrofit.

Cost-benefit analysis was used to compare the initial construction costs of the retrofit with the benefits (in terms of avoided fatalities, repair costs, and downtime in future earthquakes) to determine which option is the most effective from a financial perspective. Refer to Section VII.K for additional information about the cost-benefit analysis.

Seismic Renovation Project Feasibility Report

George E. McDonald Hall of Justice (01-F1)

Table 12. Retrofit and Replacement Options

Option	Upgrade Options			
	Seismic	Accessibility	Fire and Life Safety	Building Systems
Baseline Retrofit (Option 1)	Minimum*	Primary [†]	Minimum**	Not considered (unless impacted by retrofit work)
Priority Upgrades Retrofit (Option 2)	Minimum*	Primary [†]	Minimum**	Priority only ^{††}
Full Renovation (Option 3)	Minimum*	Full [‡]	Full [‡]	Full [‡]
Replace to 2016 CBC (Option 4)	New facility			
Replace to Beyond Code (Option 5)	New facility			

* Retrofit achieves Risk Level IV performance, which is equivalent to BPOE for Risk Category II structures as defined in ASCE 41-13. Minimum seismic upgrades apply to all segments of the court building.

[†] Primary accessibility upgrades address path-of-travel upgrades from the primary entrance to areas impacted by the seismic retrofit, including upgrades to the facilities servicing the impacted areas (e.g., toilets, signage).

[‡] Assumes complete building renovation (i.e., full accessibility, fire and life safety, and building systems upgrades). Design of such upgrades is beyond the scope of this study; however, costs are estimated for inclusion in cost-benefit analysis.

** Minimum fire and life safety upgrades include those detailed in Section VII.E.3.

^{††} Priority building system upgrades (if any) are identified from a list of approved but unfunded facility modification projects submitted to the consultant team by the individual courts. A full facility condition assessment is beyond the scope of this study.

G. Basis of Retrofit Design

The primary intent of the retrofit schemes is to reduce the seismic risk level of the building from Risk Level V to IV. As discussed in Section VII.E, Risk Level IV performance is equivalent to the BPOE for Risk Category II structures outlined in ASCE 41-13. Therefore, the seismic evaluation and retrofit procedures described in ASCE 41-13 (2014) provide the basis for the retrofit design approach used in this study.

Following the Trial Court Facilities Act of 2002, most of the 26 court buildings included in this study were evaluated per ASCE 31-03 (a predecessor to ASCE 41-13) and assigned a risk level. The reports from these seismic evaluations (executed c. 2003) were made available to the consultant team. While the reports catalog specific seismic deficiencies for each court building, changes have been made to both ASCE 41's evaluation procedures and the seismic hazard in California. Considering these changes, the consultant team, in discussion with Judicial Council Facilities Services staff, decided to conduct a supplemental ASCE 41-13 Tier 1 seismic assessment of each current existing court building using the most recent seismic hazard information for California, published in 2014 by USGS (Petersen et al. 2014).

The standard ASCE 41-13 Tier 1 Screening Procedure “consists of several sets of checklists that allow a rapid evaluation of the structural, nonstructural, and foundation and geologic

Seismic Renovation Project Feasibility Report

George E. McDonald Hall of Justice (01-F1)

hazard elements of the building and site conditions” (ASCE 2014, Section C3.3.2). For the purposes of this study, the consultant team replicated the full ASCE 41-13 Tier 1 checklist and performed relevant calculations pertinent to the changes in the evaluation code (ASCE 41-13 versus ASCE 31-03 [2003]). This included the evaluation of the adequacy of the load path of the entire seismic force-resisting system through simplified calculations. The load path includes all the horizontal and vertical components participating in the structural response of the building (e.g., floor diaphragms and vertical components such as walls, frames and braces, foundations) and the connections between each element. These calculations are required to size primary structural components within the retrofit scheme and verify overall feasibility.

A standard ASCE 41-13 Tier 1 seismic evaluation only requires identifying deficient components from standard checklists. It does not require checking the adequacy of supporting elements in the load path once the deficient components have been retrofitted, or checking the performance of the entire seismic-force-resisting system. Both checks were included in the supplemental seismic evaluations performed by the consultant team.

To inform these supplemental evaluations, the consultant team reviewed existing structural drawings and previous ASCE 31-03 Tier 1 and Tier 2 seismic assessments, and conducted site inspections to verify general conformance of existing conditions relative to the provided documents. Site inspections did not include any destructive testing to verify material properties or involve removing finishes or precast exterior cladding to confirm structural properties or specific deficiencies. In addition, no geotechnical investigations were performed to verify soil properties or liquefaction risk. Nor were any system-level analytical models of the structure developed as part of the seismic evaluation process.

Based on the deficiencies identified by the supplemental seismic evaluation, the consultant team developed a conceptual retrofit scheme for each court building using a simplified version of the process outlined in Section 1.5 of ASCE 41-13. Retrofit schemes are intended for feasibility evaluation and preliminary cost-estimation purposes only; the schemes are not detailed retrofit designs and should not serve as construction documents. An architect and Structural Engineer of Record must be engaged by the Judicial Council in the future for design development of constructible retrofit solutions. In addition to the deficiencies identified in the ASCE 31-03 reports from 2003 and the supplemental seismic evaluations performed as part of this study, the Structural Engineer of Record will need to consider any additional deficiencies that may be identified when the structures are assessed per ASCE 41-13 (or the enforceable standard at that time).

Section IV summarizes the conceptual retrofit scheme for the George E. McDonald Hall of Justice. Appendix C provides the drawing package that describes the retrofit scheme, collateral impacts, and code-required upgrades for the George E. McDonald Hall of Justice.

In general, retrofit schemes involve one or more of the following strategies permitted by ASCE 41-13:

- Local modification of components
- Removal or reduction of existing irregularities
- Global structural stiffening
- Global structural strengthening
- Mass reduction
- Seismic isolation
- Supplemental energy dissipation

While some of the strategies listed above may not be feasible or appropriate for historic structures, none of the 26 court buildings in this study are listed on the state or federal historic registers. Some, however, are classified as local points of historic interest, which may limit the retrofit interventions possible.

Refer to Section III of the detailed methodology report (Arup 2019) for additional information about the seismic evaluation and retrofit approach used in this study.

H. Determination of Collateral Impacts

Because the conceptual seismic retrofit schemes require strengthening existing structural components or installing new ones, they can have significant impact on adjacent nonstructural components, including walls, doors, windows, ceilings, floor and wall coverings, lighting, fire suppression systems, and mechanical, electrical, and plumbing systems. In addition, the seismic retrofit triggers accessibility and fire and life safety upgrades that can impact spaces that might not otherwise be affected by the retrofit work (refer to Section VII.E).

To develop relatively accurate estimates of retrofit costs, the consultant team examined the collateral impact of the retrofit scheme for each court building. Different impact categories were established to reflect the scope of work required for specific areas. For example, a category was created for spaces directly adjacent to a major structural upgrade, where the scope of work includes the following items:

- Replacement of all architectural components (floor slabs, walls, doors, windows)
- Replacement of all interior finishes (wood paneling, ceilings, carpeting, window coverings, fabric wall panels, lighting, etc.)
- Replacement of all mechanical, electrical, plumbing, audiovisual, IT, and security systems impacted by the structural upgrade, including any work required back to the central system, as necessary

Seismic Renovation Project Feasibility Report

George E. McDonald Hall of Justice (01-F1)

- Replacement of built-in/custom casework and security features (includes in-custody furniture and built-ins)
- Removal and reinstallation of furniture, fixtures, and other equipment

Other impact categories include areas of finish upgrades in rooms impacted by structural retrofit (i.e., spaces near but not directly adjacent to structural upgrades), upgrades to interior accessible path of travel (including vertical circulation), upgrades to toilet rooms, upgrades to exterior accessible path of travel (including accessible parking), and areas of landscape and hardscape upgrades made necessary by structural retrofit.

Using these categories and as-built architectural drawings (or current floor plans when available), areas within a court building were assigned to an appropriate impact category based on the seismic retrofit scheme. Consequently, cost estimates for the retrofit schemes are based on total floor areas within each category, not specific repair and refinish requirements. While attempts were made to verify the location of important court building functions (e.g., courtrooms, holding cells, toilet rooms, jury assembly rooms), the consultant team typically was unable to walk through the entire court building during the site inspections due to security issues and time constraints. As a result, collateral impacts may not be based on the most current floor plan of the court building; however, the costs developed should still be representative of the required scope of work.

Furthermore, the exact impacts of a renovation on court operations cannot be determined until a detailed retrofit design is commissioned and the timetable for construction is determined. However, the conceptual retrofit scheme provides a general understanding of impact on court operations, which informs the estimation of construction timelines and duration of leased temporary space.

I. Cost Estimation

The consultant team prepared conceptual construction cost assessments for each of the 26 existing court buildings using the proposed scopes of work for seismic upgrades, collateral impacts, fire and life safety and accessibility upgrades, priority upgrades, and other nonstructural upgrades. Where applicable, costs for hazardous materials were also identified based on input from the Judicial Council.

Costs for structural seismic work and code-required upgrades were calculated based on floor plans and narratives describing the conceptual retrofit scheme. The Judicial Council provided specific building system upgrades based on identified deferred facility modification scope items (i.e., priority upgrades). For buildings considered to be a local point of historic interest, a premium was included to cover costs for maintaining or replacing historic elements of the building. None of the buildings is on the federal or state historic buildings register, but several were identified as having features that would be considered historic.

Seismic Renovation Project Feasibility Report

George E. McDonald Hall of Justice (01-F1)

For each court building, cost assessments are provided for the three retrofit options:

- Baseline retrofit (Option 1)
- Priority upgrades retrofit (Option 2)
- Full renovation (Option 3)

For each court building, two cost scenarios were developed for both Options 1 and 2. The first cost scenario assumes **unphased construction**, meaning that construction costs are based on the building being closed and vacated during the retrofit. In this scenario, it is assumed that new commercial building space will be fit out and rented for the duration of construction. The costs assume that an area equivalent to 75 percent of the existing space occupied by the Superior Court would need to be rented.

The second cost scenario assumes **phased construction**, meaning that additional construction costs would be incurred to keep the court building open and operational. These additional costs include premiums for phasing (assuming the work would need to be done in multiple phases either by floors or zones of the buildings), a schedule premium to cover an extended construction duration due to the phasing requirements, and an escalation premium to cover increases in the cost of labor and materials due to the extended time for construction.

Option 3 assumes only unphased construction is possible due to the increased scope of work associated with full renovation (i.e., the court building cannot be occupied during construction).

Construction durations are provided for both phased and unphased construction. For unphased construction, the duration is calculated based on the estimated construction value, the size of the building, and comparison to other historical projects of a similar size and construction value. For phased construction, a duration premium is calculated for the extended construction duration to account for phasing and other restricted working conditions. This is calculated as a 3- to 6-month extended duration depending on the individual options being considered for each building.

In addition, two options for replacement of the court building are assumed:

- Replace to 2016 CBC (Option 4)
- Replace to beyond code (Option 5)

For the two replacement building options, certain key assumptions should be understood when making comparisons with the other options:

- No land costs or demolition costs are considered for the replacement buildings because these costs may not be applicable in all situations. For example, the Judicial Council could obtain land for a new facility from the city or county for free or at a significantly reduced cost. In addition, the Judicial Council may decide to sell the current existing court building to another entity instead of demolishing it.

Seismic Renovation Project Feasibility Report
George E. McDonald Hall of Justice (01-F1)

- Floor areas for the replacement buildings are based on the number of court departments at the existing court building and the median gross area per court department from recently constructed California court buildings. They exclude the floor area currently occupied by agencies other than the Judicial Council. In some cases, this has resulted in a bigger building being required, and in other cases a smaller one. Floor areas were provided to the consulting team by the Judicial Council.
- Construction costs for replacement buildings are derived from the Judicial Council cost-model database of construction costs for California Superior Court buildings of similar scope and location constructed in the recent decade. This data was provided to the consulting team by the Judicial Council.
- Construction durations for replacement buildings are estimated based on the anticipated scale and cost of the work.

The costs herein are limited to construction costs only in current dollars (2018) and market conditions, and exclude costs for future escalation because actual construction start dates have not been established at this time. Other project-related costs such as design and engineering consultant fees, loose furniture, fixtures, and equipment, and construction and owner contingencies have all been excluded. These would need to be considered and factored into overall project budgets by the Judicial Council.

J. Seismic Risk Assessment

As described in Section VII.E, the conceptual seismic retrofit scheme developed for each court building achieves BPOE for Risk Category II structures as defined in ASCE 41-13 and reduces the risk level from V to IV. The primary consequence of achieving BPOE is an overall reduction in the collapse risk of the retrofitted building. In addition, the retrofitted building is also expected to experience reduced repair costs and downtime in future earthquakes.

To estimate collapse risk and potential losses, a seismic risk assessment is performed using a probabilistic risk model. An overview of the input and output data is shown in Table 13.

Table 13. Seismic Risk Model Variables

	Variable	Definition
Inputs	Building vulnerability	How much damage a building sustains for a given size earthquake
	Seismic hazard	The level and frequency of ground shaking (e.g., how seismically active a location is)
	Exposure	The value of a building, both in terms of replacement costs, populations, and loss of life
Outputs	Casualties	Probabilistic assessment of fatalities and injuries
	Losses	Direct financial losses caused by damage to the building
	Downtime	The time it takes to reoccupy a building

The consultant team developed probabilistic risk models for each of the 26 existing court buildings and its five retrofit and replacement options. The risk models predict damage and related consequences (casualties, repair costs, repair time, and downtime) for each retrofit/replacement option and court building under various earthquake intensity levels. The building risk assessment relies on thousands of computer simulations (i.e., Monte Carlo analysis) and various earthquake scenarios to predict building damage and building risks. This is known as a fully probabilistic risk assessment. This methodology, which is detailed in Section IV of the detailed methodology report (Arup 2019), integrates the following information:

- Quantification of the seismic hazard at six intensities, ranging from frequent to very rare: 45-, 100-, 225-, 475-, 975-, 2,475-year return periods
- Anticipated building movements from simplified structural analysis at each seismic intensity
- Exposure data, including number of people within the building, quantity and type of building components, contents, and value of each building
- Vulnerability, expressed as fragility functions, that relate the anticipated building movements to damage in structural and nonstructural components and contents
- Consequences that relate the anticipated damage in each building to repair costs, repair time, downtime, casualties, and contents losses

There is significant uncertainty in predicted estimates of ground shaking, building movements, building damage incurred from those movements, and corresponding consequences. The probabilistic risk methodology addresses this uncertainty through Monte Carlo analysis, a process in which hundreds to thousands of simulations are performed to determine the range of possible outcomes in terms of collapse probability, fatalities, repair costs, and downtime. Each individual simulation randomly draws slightly different values of each input variable from a probabilistic distribution that captures uncertainty in each input. The results from these simulations are then aggregated, and mean or average values reported.

K. Cost-Benefit Analysis

Using construction cost estimates (refer to Section VII.I) and results from the seismic risk assessments (refer to Section VII.J) as inputs, the consultant team performed cost-benefit analysis to compare the financial effectiveness of the five retrofit and replacement options for each court building.

In overview, cost-benefit analysis involves quantification of the benefits and costs stemming from a particular action — in this study, the retrofit or replacement of a court building. In terms of benefits, the primary consideration is the reduction in seismic risk associated with each retrofit or replacement option. Each option will improve the performance of a court building in future earthquakes to varying degree. The benefits of this improved seismic

Seismic Renovation Project Feasibility Report
George E. McDonald Hall of Justice (01-F1)

performance take the form of reduced (or avoided) fatalities, repair costs, and downtime in future earthquakes. The benefit is then compared to costs of construction. Table 14 provides a breakdown of the variables considered.

Table 14. Cost-Benefit Analysis Variables

Concept	Definition
Benefit-cost ratio (BCR)	The ratio of the benefit of the seismic retrofit to the cost to implement it. A BCR above 1 indicates the benefits exceed the costs. The BCR provides valuable information even when it is below 1 — BCRs ratings can inform the basis for prioritization and selection of the preferred option.
Benefit	The total decrease in loss, when compared to the existing, non-retrofitted building. This benefit is cumulative over the asset-life extension and is priced as a net present value. The benefit considers improvements in seismic performance only.
Loss	Sum of financial losses, which includes financial loss from fatalities, repair costs, and downtime. Can be expressed as an average annualized loss over the asset life.
Asset-life extension	For a given retrofit or replacement option, the assumed life of the building before further renovation is required. This is used to calculate total benefit.
Net present value	The value of something based upon today’s money. The calculation of net present value requires an assumption about the discount rate.
Cost	Construction cost of the new/retrofitted building. This is measured in 2018 dollars, not net present value.

The cost-benefit analysis considers a range of seismic intensities, from rare earthquakes to more frequent ones, which can also generate significant loss and downtime. Risk results from each intensity are used to compute annualized losses for each retrofit and replacement option in terms of casualties, repair costs, and downtime. Annualized losses for each option are subtracted from the annualized losses for the current existing court building to compute the net annual benefits of the option. Net annual benefits are summed over the assumed asset-life extension of the option (see Table 15) and discounted to present value to obtain the net present value of benefits.

The assumed asset-life extension is an important variable in the calculation, as it determines the length of time over which the benefits of retrofit or replacement can accrue. Asset-life extension is the assumed length of time — after a renovation — to the next necessary building-wide renovation or replacement. It is not a prediction of the length of court occupancy in the building (i.e., the court will not abandon or move out of the building at the end of the assumed asset-life extension). Table 15 summarizes the values of asset-life extension assumed for each option. Longer asset-life extension means that the benefits of a retrofit or replacement option have more time to accrue, thus making the option more effective from a financial perspective. The trade-off, however, is that the full renovation and replacement options, which have longer asset-life extensions than the baseline retrofit, often have significantly larger initial construction costs.

Seismic Renovation Project Feasibility Report
George E. McDonald Hall of Justice (01-F1)

Table 15. Assumed Asset-Life Extension for Each Retrofit and Replacement Option

Option	Assumed Asset-Life Extension	Notes
1. Baseline retrofit	15 years	A relatively short asset-life extension is assumed because the baseline retrofit does not address deficient building systems, which are conservatively assumed to have 15 years remaining life. The benefits of the seismic retrofit do not cease after 15 years; however, to continue to occupy the building comfortably, additional investment would be required at that time.
2. Priority upgrades retrofit	25 years	A longer asset-life extension than the baseline retrofit is assumed because deficient building systems are replaced.
3. Full renovation	40 years	A longer asset-life extension than the priority upgrades retrofit is assumed because an entirely new building interior and facade is installed (e.g., all building systems are replaced, a more efficient and secure court layout is implemented).
4. Replace to 2016 CBC	50 years	An asset-life extension consistent with the typical design life for new building is assumed, though buildings can be occupied longer.
5. Replace to beyond code	50 years	An asset-life extension consistent with the typical design life for new building is assumed, though buildings can be occupied longer.

The discount rate is another important variable in determining net present value. Because a dollar in the future is not worth the same as a dollar today, the benefits of retrofit or replacement that accrue in the future need to be converted to present value via the discount rate. Larger discount rate values mean that money today is worth significantly more than money in the future. The federal government requires a discount rate of 7 percent for cost-benefit analysis, which is at the higher end of the range found in the published literature, reflecting the government’s tendency to prioritize actions where the benefits accrue quickly (as opposed to 20 years in the future). In previous cost-benefit analyses, the consultant team used discount rates closer to 5 percent. For this study, the Judicial Council Facilities Services selected a value of 6 percent.

The cost-benefit analysis involves estimating construction costs for each retrofit and replacement option, which is summarized in Section VII.I. Together, the construction costs and the net present value of benefits can be used to compute the benefit-cost ratio (BCR) via Equation 1 below. A benefit-cost ratio greater than 1 indicates that the benefits of the option (in terms of avoided casualties, repair costs, and downtime in future earthquakes), over the assumed asset-life extension, exceed the initial construction costs. Based on the consultant team’s prior experience, it is not uncommon that BCRs for all options remain below 1; however, in this instance, the BCRs are still useful in terms of prioritizing which option makes the most sense to pursue.

Seismic Renovation Project Feasibility Report
George E. McDonald Hall of Justice (01-F1)

$$BCR_i = \frac{NPV_{b,i}}{NPV_{c,i}} \quad \text{Equation 1}$$

Where:

BCR_i = benefit-cost ratio of Option i

$NPV_{b,i}$ = net present value of benefits for Option i (see Equation 2)

$NPV_{c,i}$ = net present value of costs for Option i
= total construction costs for Option i

Equation 2 provides the formula used to calculate the net present value of benefits.

$$NPV_{b,i} = \Delta AAL_i \left[\frac{1 - \frac{1}{(1+r)^{T_i}}}{r} \right] \quad \text{Equation 2}$$

Where:

$NPV_{b,i}$ = net present value of benefits for Option i

ΔAAL_i = net annual benefits of Option i , where $i = 1, \dots, 5$
= $AAL_{existing} - AAL_i$

$AAL_{existing}$ = annualized losses for current existing court building

AAL_i = annualized losses for Option i

T_i = assumed asset-life extension of Option i (see Table 15)

r = discount rate, which measures the value of money in the future

Refer to Section V of the detailed methodology report (Arup 2019) for additional information about the cost-benefit methodology. The scope of costs and benefits included in the analysis is summarized in Table 16.

Seismic Renovation Project Feasibility Report
George E. McDonald Hall of Justice (01-F1)

Table 16. Summary of Costs and Benefits Included in Cost-Benefit Analysis

Item	Included in cost-benefit analysis					Notes
	Retrofit or replacement option					
	1	2	3	4	5	
<i>Costs</i>						
Hard construction costs	Yes	Yes	Yes	Yes	Yes	Includes costs of site preparation, design contingencies, and labor and material required for repair or construction of substructure, shell, interiors, and building services (as applicable). For Options 1 and 2, the costs of upgrades to accessibility and fire and life safety systems were explicitly calculated. For Options 3-5, compliance with current accessibility and fire and life safety requirements is assumed as part of the construction work.
Temporary relocation costs	Yes	Yes	Yes	N/A	N/A	For Options 1-3 (unphased), includes fit out and rental costs required to relocate court staff and functions to temporary space for the duration of the retrofit. For Options 4-5, temporary relocation costs are not applicable because it is assumed court staff and functions can remain in the existing court building while the new one is constructed in a nearby location.
Construction phasing costs	Yes	Yes	No	N/A	N/A	For Options 1 and 2 (phased), includes costs for phasing the construction work by zones or floors to keep the court building open during the retrofit. For Option 3, construction phasing costs were not included because phasing was assumed to be impractical due to disruptiveness of the construction work.
Demolition costs	N/A	N/A	N/A	No	No	For Options 4 and 5, does not include costs of demolishing current existing building. For Options 1-3, demolition costs are not applicable.
Land costs	N/A	N/A	N/A	No	No	For Options 4 and 5, does not include costs of acquiring land for new court building. For Options 1-3, demolition costs are not applicable.
Escalation costs	No	No	No	No	No	Does not include escalation in construction costs from the time of this study to the actual start of a retrofit or replacement project.
Design and engineering consultant fees	No	No	No	No	No	Does not include consultant fees for further engineering analyses or detailed design services prior to retrofit or replacement of a court building.
Construction and owner contingencies	No	No	No	No	No	
Loose furniture, fixtures, and equipment	No	No	No	No	No	

Seismic Renovation Project Feasibility Report
George E. McDonald Hall of Justice (01-F1)

Item	Included in cost-benefit analysis					Notes
	Retrofit or replacement option					
	1	2	3	4	5	
<i>Benefits</i>						
Avoided injuries in future earthquakes	No	No	No	No	No	Does not include the benefit of avoided injuries due to incomplete data on the financial cost of injuries.
Avoided fatalities in future earthquakes	Yes	Yes	Yes	Yes	Yes	Includes the benefit of avoided fatalities. Fatalities were calculated using peak instantaneous building populations, which were derived from magnetometer counts for each court building, and 90 th percentile estimates of fatalities from the seismic risk assessment. The value of a statistical life (i.e., cost of a fatality) was selected to be \$9 million for this study. Refer to the detailed methodology report (Arup 2019) for further discussion.
Avoided repair costs in future earthquakes	Yes	Yes	Yes	Yes	Yes	Includes costs to repair damage to major structural and nonstructural components. Does not include losses from damage to building contents (e.g., furniture, computers).
Avoided downtime in future earthquakes	Yes	Yes	Yes	Yes	Yes	Includes cost to fit out and rent temporary space for the duration of repair work after an earthquake. Does not include indirect costs from protracted downtime (e.g., increased backlog of court cases, employee attrition)
Improved energy efficiency	No	No	No	No	No	Does not include the benefit of improved energy efficiency from replacing existing mechanical and electrical equipment.
Improved accessibility	No	No	No	No	No	
Improved fire and life safety	No	No	No	No	No	
Improved functionality	No	No	No	No	No	Does not include the benefit of improved functionality from construction work, including possible improvements to daylighting, security, and building layout.
<i>Asset-life extension</i>						
Minimum asset-life extension (years)	15	25	40	50	50	Asset-life extension refers to the assumed life time of a building before further necessary building-wide renovation or replacement is required. It is the length of time over which the benefits (above) are assumed to accrue. It is not a prediction of the length of actual court occupancy in a particular building. Refer to the detailed methodology report (Arup 2019) for further discussion.

L. Decision-Making Process

The benefit-cost ratio is one of many outputs used by the Judicial Council in selecting a retrofit or replacement option for each court building. Figure 4 summarizes the range of factors included in the decision-making process and distinguishes between those provided by the consultant team and those provided by the Judicial Council.

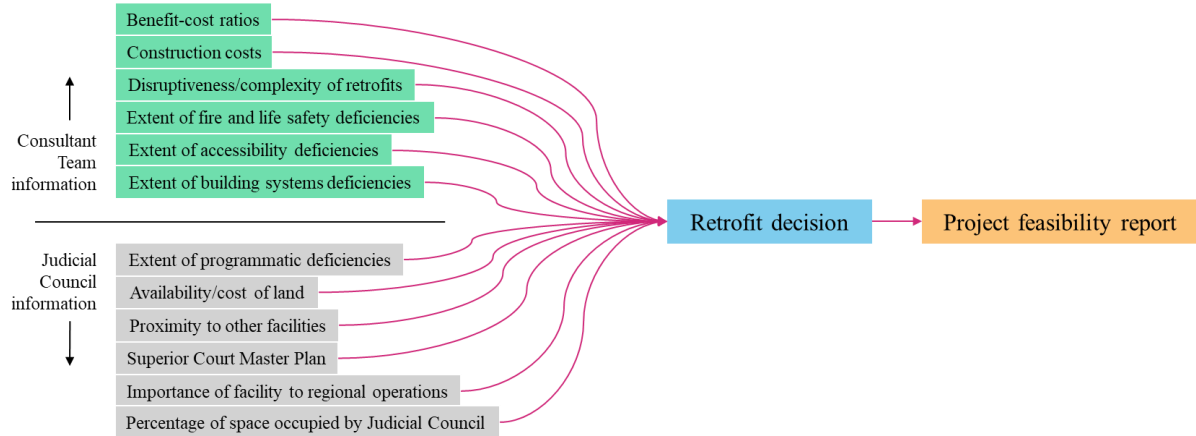

Figure 4. List of Factors Considered in Selection of Retrofit or Replacement Option

The primary consideration in the decision-making process was the benefit-cost ratio (BCR) because, as described in Section VII.K, it incorporates a wide range of factors into a single measure, including the reduction in seismic risks (e.g., casualties, repair costs, downtime), asset-life extension, and total construction costs. If the retrofit or replacement option with the highest BCR had a value that was significantly larger than the option with the next highest BCR value (the consultant team established 25 percent as the threshold for significantly larger), then it was selected as the option to pursue. The 25 percent threshold was established because the uncertainty in calculating the BCR was such that two values within ± 25 percent of each other could be considered similar.

If the BCRs for each option were similar, then additional metrics were considered in the selection process, including total construction costs, cost per square foot, and the ratio of total construction costs to asset-life extension.

The specific justification for the option selected for the George E. McDonald Hall of Justice is provided in Section IV.

VIII. REFERENCES

- American Society of Civil Engineers (ASCE). 2003. *Seismic Evaluation of Existing Buildings (31-03)*.
- . 2007. *Seismic Rehabilitation of Existing Buildings (41-06)*.
- . 2013. *Minimum Design Loads for Buildings and Other Structures (7-10)*. Third printing.
- . 2014. *Seismic Evaluation and Retrofit of Existing Buildings (41-13)*.
- . 2017. *Seismic Evaluation and Retrofit of Existing Buildings (41-17)*.
- Arup. 2013. *REDi Rating System: Resilience-Based Earthquake Design Initiative for the Next Generation of Buildings*. Version 1.0.
- . 2019. *Detailed Methodology: California Superior Court Buildings Seismic Renovation Feasibility Studies Project*. Prepared for the Judicial Council of California.
- California Building Standards Commission (CBSC). 2016a. *California Building Standards Code*. California Code of Regulations. Title 24. Part 2: California Building Code.
- . 2016b. *California Building Standards Code*. California Code of Regulations. Title 24. Part 9: California Fire Code.
- . 2016c. *California Building Standards Code*. California Code of Regulations. Title 24. Part 10: California Existing Building Code.
- Department of General Services (DGS). 2009. *Seismic Independent Review Report*.
<https://www.documents.dgs.ca.gov/resd/RELPS/SeismicIndependentReviewReport.pdf>.
- Federal Emergency Management Agency (FEMA). 2012. *Seismic Performance Assessment of Buildings: Volume 1 – Methodology*. FEMA P-58-1. https://www.fema.gov/media-library-data/1396495019848-0c9252aac91dd1854dc378feb9e69216/FEMAP-58_Volume1_508.pdf.
- . 2015. *Rapid Visual Screening of Buildings for Potential Seismic Hazards: A Handbook*. FEMA P-154. Third Edition. Washington, D.C.
- Jones, Lucile M., Richard Bernknopf, Dale Cox, James Goltz, Kenneth Hudnut, Dennis Mileti, Suzanne Perry, et al. 2008. *The ShakeOut Scenario*. United States Geological Survey Open-File Report 2008-1150 and California Geological Survey Preliminary Report 25. Version 1.0.
<https://pubs.usgs.gov/of/2008/1150/>.
- Judicial Council of California. 2011. *California Trial Court Facilities Standards*.
<http://www.courts.ca.gov/documents/ctcfs2011.pdf>
- Petersen, Mark D., Morgan P. Moschetti, Peter M. Powers, Charles S. Mueller, Kathleen M. Haller, Arthur D. Frankel, Yuehua Zeng, et al. 2014. *Documentation for the 2014 Update of*

Seismic Renovation Project Feasibility Report
George E. McDonald Hall of Justice (01-F1)

the United States National Seismic Hazard Maps. United States Geological Survey Open-File Report 2014-1091. <https://pubs.usgs.gov/of/2014/1091/pdf/ofr2014-1091.pdf>.

Rutherford + Chekene (R+C). 2017. *Seismic Risk Rating of California Superior Court Buildings: Volume 1 & 2*. Prepared for the Judicial Council of California.
<http://www.courts.ca.gov/documents/Seismic-Risk-Rating-of-California-Superior-Court-Buildings.pdf>.

Trial Court Facilities Act of 2002. Senate Bill 1732, Statutes 2002, Chapter 1082.

United States Geological Survey (USGS). 2000. Preliminary Maps of Quaternary Deposits and Liquefaction Susceptibility, Nine-County San Francisco Bay Region, California: A Digital Database. USGS Open-File Report 00-444. Online version 1.0.
<http://pubs.usgs.gov/of/2000/of00-444/>.

———. 2006. Maps of Quaternary Deposits and Liquefaction Susceptibility in the Central San Francisco Bay Region, California. USGS Open-File Report 2006-1037. Version 1.1.
<http://pubs.usgs.gov/of/2006/1037/>.

APPENDIX A. ABBREVIATIONS AND GLOSSARY

**Seismic Renovation Project Feasibility Report
George E. McDonald Hall of Justice (01-F1)**

A. Abbreviations

ASCE	American Society of Civil Engineers
BCR	benefit-cost ratio
BPOE	basic performance objective for existing buildings
CBC	California Building Code
CBSC	California Building Standards Commission
CEBC	California Existing Building Code
FEMA	Federal Emergency Management Agency
R+C	Rutherford + Chekene
REDi	Resilience-based Earthquake Design Initiative
SRR	seismic risk rating
USGS	United States Geological Survey

B. Glossary

Asset-life extension – For a given retrofit or replacement option, the assumed life time of a building before further necessary building-wide renovation or replacement renovation is required. This is used to calculate total benefit. Asset-life extension is not a prediction of the length of actual court occupancy in a particular building.

Baseline retrofit option (Option 1) – A retrofit option that represents the minimum level of effort and expenditure to mitigate the seismic risk at a court building, including seismic upgrades to structural and nonstructural components (e.g., stairs, elevators, ceilings, lights, partitions) to achieve Risk Level IV performance (i.e., ASCE 41-13 BPOE for Risk Category II structures), nonstructural repairs made necessary by the retrofit, and triggered upgrades to accessibility and fire and life safety systems.

Building segment – A portion of a building that may respond independently of other sections in an earthquake. Building segments can have very different properties (e.g., construction material and number of floors), and can be built at different times. However, from an operational perspective, they typically function together as a single facility.

Building type – A classification that groups buildings with common seismic-force-resisting systems and performance characteristics in past earthquakes. The building types relevant to the 26 court buildings in this study include those listed in the table below (ASCE 2003):

Type	Description
C1	Concrete moment frames
C2	Concrete shear walls with stiff diaphragms

Seismic Renovation Project Feasibility Report George E. McDonald Hall of Justice (01-F1)

Type	Description
C2A	Concrete shear walls with flexible diaphragms
PC1A	Precast/tilt-up concrete shear walls with stiff diaphragms
RM1	Reinforced masonry bearing walls with flexible diaphragms
RM2	Reinforced masonry bearing walls with stiff diaphragms
S1	Steel moment frames with stiff diaphragms
S2	Steel braced frames with stiff diaphragms
S4	Steel frames with concrete shear walls
URM	Unreinforced masonry bearing walls with flexible diaphragms

California Building Code (CBC) – The set of regulations in California that governs how new buildings are designed and constructed.

California Existing Building Code (CEBC) – The set of regulations in California that governs how existing buildings are repaired, altered, or expanded.

Collapse prevention performance – A post-earthquake damage state in which a building is on the verge of partial or total collapse. Substantial damage to the structure has occurred, potentially including significant degradation in the stiffness and strength of the lateral-force-resisting system, large permanent lateral deformation of the structure, and—to a more limited extent—degradation in vertical-load-carrying capacity. However, all significant components of the gravity-load-resisting system must continue to carry their gravity loads. Significant risk of injury caused by falling hazards from structural debris might exist. The structure might not be technically practical to repair and is not safe for re-occupancy because aftershock activity could induce collapse.

Collapse probability – The likelihood that a building will either partially or totally collapse in an earthquake. FEMA P-154 (2015) defines *collapse* as when the gravity load carrying system in one part or all of the building loses the ability to carry the weight.

Collateral impacts – Repair work to nonstructural components (e.g., walls, ceilings, lighting, carpeting) made necessary by the seismic retrofit.

Design basis earthquake – A level of ground shaking defined in the design standards for new buildings. For California, this has a return period of between 200 and 800 years.

FEMA P-58 risk assessments – A standard engineering method for quantifying the seismic performance of a building in terms of casualties, repair costs, and repair time.

Full renovation option (Option 3) – A retrofit option that includes the same seismic upgrades to structural components as the baseline retrofit option, plus full demolition and replacement of the interior down to the structural skeleton and removal of the exterior wall and roof cladding.

Seismic Renovation Project Feasibility Report

George E. McDonald Hall of Justice (01-F1)

Note that the budget for the nonstructural components is based unit costs per square foot, and no design was performed as part of this study.

Life safety performance – A post-earthquake damage state in which significant damage to a building has occurred but some margin against either partial or total structural collapse remains. Some structural components are severely damaged, but this damage has not resulted in large falling debris hazards, either inside or outside the building. Injuries might occur during the earthquake; however, the overall risk of life-threatening injury from structural damage is expected to be low. It should be possible to repair the structure; however, for economic reasons, this repair might not be practical. Although the damaged structure is not an imminent collapse risk, it would be prudent to implement structural repairs or install temporary bracing before re-occupancy.

Nonstructural components – Architectural, mechanical, and electrical components of a building permanently installed in or integral to a building system.

Phased construction – A scenario in which the court building would be kept open and operational during the retrofit, requiring the work would need to be done in multiple phases either by floors or zones of the buildings.

Priority upgrades – A list of approved, unfunded facility modifications at a court building. Priority upgrades do not include all possible maintenance needs at a court building.

Priority upgrades retrofit option (Option 2) – A retrofit option that includes the same upgrades as the baseline retrofit option, plus any priority upgrades. This retrofit option was included in the study because seismic retrofits often provide an opportunity to upgrade outdated or deficient building systems (which would normally be highly disruptive) at relatively little additional cost

Replace to 2016 CBC option (Option 4) – A replacement option that involves replacing an existing court building with a new facility that satisfies Risk Category III requirements of the 2016 California Building Code (CBC). Risk Category III refers to “buildings and structures that could pose a substantial risk to human life in case of damage or failure,” including those with a potential to cause “a substantial economic impact and/or mass disruption of day-to-day civilian life” (ASCE 2013). California Superior Court buildings are classified as Risk Category III because of the consistent large density of occupants in these public buildings.

Replace to beyond code option (Option 5) – A replacement option that involves replacing an existing court building with a new facility that goes beyond the minimum requirements of the 2016 CBC to achieve more resilient seismic performance (e.g., reduced damage, repair costs, and downtime).

Seismic risk rating (SRR) – A ranking based on the relative probability of collapse in a seismic event as estimated by a Hazus model of the building, which considers the structural capacity of the building, site-specific seismic hazard, and structural characteristics that influence the

Seismic Renovation Project Feasibility Report
George E. McDonald Hall of Justice (01-F1)

capacity or response to earthquakes. Court buildings with SRRs exceeding 10 are classified as Very High Risk, while those with SRRs between 2 and 10 are classified as High Risk.

Structural components – Components of a building that provide gravity- or lateral-load resistance as part of a continuous load path to the foundation, including beams, columns, slabs, braces, walls, wall piers, coupling beams, and connections.

Supplemental ASCE 41-13 Tier 1 seismic assessment – A standard ASCE 41-13 Tier 1 seismic evaluation involves completing checklists of evaluation statements to identify seismic deficiencies in a building based on performance of similar buildings in past earthquakes. It does not require checking the adequacy of supporting elements in the load path once the deficient components have been retrofitted, or checking the performance of the entire seismic-force-resisting system. Both checks were included in the supplemental seismic evaluations performed by the consultant team.

Unphased construction – A scenario in which the court building is closed and vacated during construction, requiring court staff and functions to be relocated to a temporary facility.

APPENDIX B. SUMMARY SHEET

Seismic Renovation Project Feasibility Report
George E. McDonald Hall of Justice (01-F1)

Appendix B provides the two-page summary sheet developed for the George E. McDonald Hall of Justice. In overview, the first page describes the condition of the existing court building, while the second page compares each of the five retrofit and replacement options. More specifically, the summary sheet does the following:

- Provides basic information about the court building
- Lists deficiencies (structural and fire and life safety), priority upgrades, and key assumptions and project risks
- Describes seismic retrofit measures, fire and life safety upgrades, and accessibility upgrades
- For each of the five retrofit and replacement options, summarizes construction costs and results from the cost-benefit analysis

Basic courthouse information

Address	2233 Shoreline Dr., Alameda
No. of building segments	1 (01-F1)
Year constructed	1970
Total floor area (ft²)	25,850
% area occupied by JCC	100
Total height (ft)	27
No. of stories above/below ground	2/0
Building type	S1
Seismic risk rating	6.2
No. of courtrooms	3
No. of daily workers	45
No. of daily visitors	200
Asbestos	No
Historical	No
Liquefaction tier	Very High
Replacement value	\$30.4 million

Legend Building Type	
C1	Concrete Moment Frames
C2	Concrete Shear Walls with Stiff Diaphragms
C2A	Concrete Shear Walls with Flexible Diaphragms
PC1A	Precast/Tilt-up Concrete Shear Walls with Stiff Diaphragms
RM1	Reinforced Masonry Bearing Walls with Flexible Diaphragms
RM2	Reinforced Masonry Bearing Walls with Stiff Diaphragms
S1	Steel Moment Frames with Stiff Diaphragms
S2	Steel Braced Frames with Stiff Diaphragms
S4	Steel Frames with Concrete Shear Walls
URM	Unreinforced Masonry Bearing Walls with Flexible Diaphragms

**Overall facility condition**

- | | |
|--------------------------|--|
| Structural | <ul style="list-style-type: none"> ● Interstory drift is too high ● Perimeter frames are discontinuous and therefore ineffective ● Nonstructural: Concrete panels are heavy and not well-connected to the structure ● Nonstructural: Stairs are not detailed to accommodate interstory drift |
| Fire life safety | <ul style="list-style-type: none"> ● No annunciator panel |
| Priority upgrades | <ul style="list-style-type: none"> ● Replace air handler unit |

Key assumptions and project risks

- Courthouse has Very High liquefaction risk. The proposed retrofit scheme does not mitigate liquefaction risk. To determine the extent of foundation retrofit required, a site-specific geotechnical investigation is required. If foundation retrofit required, it will likely increase retrofit costs relative to those presented herein.
- The courthouse is vulnerable to sea level rise and is projected to be in the 100-year storm flood plain in 100 years (assuming 5.7 feet of sea level rise over the next 100 years).
- Refer to Section VI for a complete list of project risks and assumptions

	Option	1. Baseline retrofit	2. Priority upgrades	3. Full renovation	4. Replace to 2016 CBC	5. Replace to beyond code
Summary of renovations	Seismic upgrades (see drawings for further detail)	<ul style="list-style-type: none"> Add BRBFs as the main seismic system and limit drift to 1% Add additional anchors to connect panels to structure 			N/A - New construction (Risk Category 3)	N/A - New construction (e.g. REDi Gold)
	Fire life safety upgrades ¹ (see drawings)	<ul style="list-style-type: none"> Provide emergency responder radio coverage Provide fire alarm system with both automatic and manual fire alarm systems in holding cells 		N/A - Full renovation	N/A - New construction (Risk Category 3)	N/A - New construction (e.g. REDi Gold)
	Accessibility upgrades (see drawings)	<ul style="list-style-type: none"> ADA upgrades to toilet facilities Path of travel upgrades to impacted spaces 		N/A - Full renovation	N/A - New construction (Risk Category 3)	N/A - New construction (e.g. REDi Gold)
	Priority upgrades	N/A	See Page 1	N/A - Full renovation	N/A - New construction (Risk Category 3)	N/A - New construction (e.g. REDi Gold)
Construction costs	Construction costs ^{2,3}	\$13.7 million (45% replacement)	\$15.3 million (50% replacement)	\$17.6 million (58% replacement)	\$30.4 million (100% replacement)	\$32.0 million (105% replacement)
	Cost of temporary relocation	\$6.0 million (20% replacement)	\$6.0 million (20% replacement)	\$6.3 million (21% replacement)	N/A	N/A
	Cost to phase construction	\$2.8 million (9% replacement)	\$3.1 million (10% replacement)	N/A	N/A	N/A
	Construction duration	14 months (18 months if phased)	14 months (18 months if phased)	18 months	24 months	24 months
	Total costs	\$19.7 million (\$16.5 million if phased)	\$21.3 million (\$18.4 million if phased)	\$23.9 million (79% replacement)	\$30.4 million (100% replacement)	\$32.0 million (105% replacement)
	Cost per sq ft	\$762 (\$639 if phased)	\$824 (\$711 if phased)	\$925	\$825	\$866
Risk + CBA	Benefit cost ratio	1.139 (1.360 if phased)	1.387 (1.607 if phased)	1.455	1.270	1.235
	Asset life extension	15 years	25 years	40 years	50 years	50 years
	GFA (sq ft)	25,850			36,900	

Notes

- Subject to determination by fire code official
- Excludes soft costs, land costs, and cost to lease temporary space
- Assumes facility is fully closed during renovation

APPENDIX C. SEISMIC RETROFIT DRAWINGS

Seismic Renovation Project Feasibility Report

George E. McDonald Hall of Justice (01-F1)

Appendix C provides architectural and structural drawings of the conceptual seismic retrofit scheme developed by the consultant team for the George E. McDonald Hall of Justice.

The drawings generally show the extent and impact of the conceptual retrofit scheme, including collateral impacts and code-required upgrades to accessibility and fire and life safety. Standard structural details (typically taken from FEMA 547) were leveraged to convey the intent of the retrofit scheme; consequently, they may not reflect the actual construction of the court building. For example, while the gravity framing in the court building may be cast-in-place concrete beams and columns, the retrofit detail for strengthening a concrete floor diaphragm chord might show precast concrete framing below the cast-in-place concrete slab. The structural details are not intended to serve as a construction documents but rather convey the feasibility of the conceptual retrofit scheme and, therefore, are appropriate at this stage of design. Additionally, the structural sizes and quantities specified in the drawings (e.g., number and size of steel reinforcing bars in concrete shear walls) are indicative of the scope and extent of the retrofit for the purposes of verifying overall feasibility and costs, and should not be used for the purposes of construction.

Furthermore, the retrofit scheme is based on limited information and seismic analysis and, therefore, is subject to the following limitations:

- No materials testing, geotechnical studies, or intrusive testing were performed.
- An analytical model of the building was not developed.
- Design optimization was not carried out (i.e., minimizing collateral impacts and construction costs).

To address these limitations, the consultant team made conservative assumptions about the overall condition of the facility (e.g., material strengths, connection details) to understand and test the feasibility of retrofitting the court building. This likely results in a conservative retrofit scheme and an upper bound on collateral impacts and construction costs (i.e., some retrofit measures may not be required or can be scaled back after further investigation, or alternative retrofit schemes might be possible). While this is appropriate for feasibility studies and budgetary checking, a more thorough engineering study would need to be performed prior to construction.

Conceptual Retrofit Drawing Package for 01-F1 George E. McDonald Hall of Justice



Overview of retrofit and replacement options

Option	Description
1. Baseline Retrofit	This option includes seismic upgrades to structural and nonstructural components, and architectural repairs made necessary by the retrofit, and triggered upgrades to fire life safety and accessibility. Structural seismic upgrades are described in the structural sheets (see S0, etc.), while nonstructural seismic upgrades are described in the general notes (see GN2). Architectural repairs and triggered upgrades to fire life safety and accessibility are described in the architectural sheets (see A0.00, A1.01, A1.02, etc.). All building segments are assumed to be upgraded as part of the baseline seismic retrofit.
2. Priority Upgrades Retrofit	This option involves the same upgrades as described above for Option 1, plus priority upgrades, if any.
3. Full Renovation	This option includes the same seismic upgrades to structural components as described above for Option 1 (see sheets S0, etc.), plus full demolition and replacement of the building interior down to the structural skeleton. Note that the nonstructural seismic upgrades described on sheet GN2 and the architectural repairs and triggered upgrades to fire life safety and accessibility described in the architectural sheets do not apply to this option.
4. Replace to 2016 CBC	This option involves demolishing the existing courthouse and replacing it with a new facility of appropriate size that satisfies Risk Category III requirements of the 2016 CBC. Design of this replacement facility is beyond the scope of this study.
5. Replace to Beyond Code	This option involves demolishing the existing courthouse and replacing it with a new facility of appropriate size that goes beyond the requirements of the 2016 CBC to achieve resilience objectives that minimize damage and loss of function in future earthquakes. Design of this replacement facility is beyond the scope of this study.

Basic courthouse information

Address	2233 Shoreline Dr., Alameda
No. of building segments	1
Year constructed	1970
Total floor area (sq ft)	25,850
Height (ft)	27
No. of stories above/below ground	2 / 0
Building type	S1
Number of court departments	3
Asbestos	No

Job: Judicial Council	Job #: 259713
Title: 01-F1 George E. McDonald Hall of Justice	
General Notes	
Prepared By:	Page: GN1
Sketch #: Courthouse overview	ARUP
Date: 2018-07-02	
Scale: As Noted	
Original paper size: 11" x 17"	

Conceptual Retrofit Drawing Package for 01-F1 George E. McDonald Hall of Justice

Table of required seismic upgrades to nonstructural components (only applicable to Options 1 and 2)

Component type	Scope	Metric description	Quantity
<i>Architectural</i>			
Exterior - cladding and glazing	Adhered or anchored veneer, glass blocks, nonstructural masonry, prefabricated panels, glazed wall systems	Total area of façade to be removed and replaced. If historic, assume façade is preserved and strengthened. Assume replacement cost is equivalent to Modesto courthouse façade.	Facility condition report indicates 13,750 sq ft of precast concrete cladding; unable to verify connection details (because full set of as-built structural drawings unavailable), therefore panels assumed to be life safety risk
Interior - partitions	Heavy, unreinforced masonry, hollow clay tile, or glazed	Demolition and replacement of partitions is not costed, but presence is noted in courthouse narrative.	N/A
Interior - finishes	Stone, including marble	Preservation of stone/marble finishes not costed, but presence is noted in courthouse narrative.	N/A
Parapets, cornices, architectural appendages, chimneys	Any type	Removal or bracing of parapets, chimneys, etc. is not costed, but presence is noted in project narrative.	N/A
Stairs	Any type	Total number of stairwells to be demolished and replaced.	N/A
Doors	If required for emergency services egress	Not applicable to courthouses, therefore not costed.	N/A
<i>Mechanical and electrical equipment</i>			
Mechanical equipment	Containing hazardous material or fire suppression equipment, HVAC equipment mounted in-line with ductwork	Assume all existing equipment to be retrofitted; therefore use courthouse area for costing.	Use total courthouse area
Electrical equipment	Required for emergency power	Assume all existing equipment to be retrofitted; therefore use courthouse area for costing.	Use total courthouse area
<i>Building services and systems</i>			
Architectural ceilings	Suspended lath and plaster, dropped furred gypsum board, or directly applied to structure and >10 SF	Total area of ceiling to be removed and replaced.	N/A
Ducting	Containing hazardous material, stair or smoke ducts, or >6 SF	Total length of ducting to be braced (may trigger extensive removal of ceilings).	N/A
Plumbing	Containing hazardous materials, required for fire suppression, or pressure piping	Total length of piping to be braced (may trigger extensive removal of ceilings).	Building is fully sprinkled; MGAC to use project experience to develop cost
Light fixtures	If pendant and exceeds 20 LB per support	Not costed	N/A
Elevators	Any type	Number of elevators to be modernized (i.e., replace everything but elevator shaft)	1
<i>Furnishings</i>			
Storage racks and other contents	In occupied spaces; tall and narrow or fall-prone contents	Total floor area with racks/contents that require bracing	2% of courthouse area

Job: Judicial Council	Job #: 259713
Title: 01-F1 George E. McDonald Hall of Justice	
General Notes	
Prepared By:	Page: GN2
Sketch #: Courthouse overview	ARUP
Date: 2018-07-02	
Scale: As Noted	
Original paper size: 11" x 17"	

LEGEND



Structural retrofit affecting the building interior
See structural report.



Structural retrofit affecting the building exterior
See Structural report. Scope of work to include but not limited to:
•Exterior skin / envelope replacement
•Exterior skin / envelope repair

1



Area of full interior renovation made necessary by structural retrofit
Scope of work to include but not limited to:
•Replacement or repair of elements affected by structural retrofit (floor slabs, windows, etc.)
•Removal of all non-structural architectural elements (walls, doors, ceilings), and replacement in a new configuration
•Removal and replacement of all interior finishes (wood paneling, ceilings, carpeting, window coverings, fabric wall panels, lighting, etc.)
•Removal and replacement of all MEP AV-IT and security systems, including work back to central system, as required
•Removal and replacement of built-in/custom casework, FF&E, and security features (includes in-custody furniture and built-ins)
•Installation of new fire protection systems (fire sprinklers, fire alarms, etc.)
•All new construction shall comply with current codes.

2



Area of major architectural repair made necessary by structural retrofit
Scope of work to include but not limited to:
•Replacement of all architectural elements (floor slabs, walls, doors, windows)
•Replacement of all interior finishes (wood paneling, ceilings, carpeting, window coverings, fabric wall panels, lighting, etc.)
•Replacement of all MEP AV-IT and security systems impacted by the structural upgrade, including work back to central system, as required
•Replacement of built-in/custom casework and security features (includes in-custody furniture and built-ins)
•Removal and re-installation of FF&E

3



Area of finish upgrades in rooms impacted by structural retrofit
Scope of work to include, but not limited to:
•Replacement of floor finishes for entire room (VCT, Carpeting, etc.)
•Repainting of entire room
•Ceilings
•Rooms 150 sf or less, replace entire ceiling and lighting system
•Rooms greater than 150 sf, patch and repair



Elevator
Coordinate all work with existing maintenance projects and path of travel upgrades. See above.



Area of fire alarm system upgrades

NOTES

1. Upgrades described in the architectural plans apply only to retrofit options 1 and 2
2. Hazardous materials abatement is not quantified in these diagrams.
3. Annotated architectural plans do not quantify any below-grade construction or work related to foundation or footing retrofit. See structural report for extents of below-grade work.

4



Upgrades to interior accessible path of travel
Scope of work to include but not limited to ADA compliant upgrades to:
•Drinking fountains
•Public telephones
•Door Hardware
•Stair tread and riser markings
•Stair guardrails and handrails
•Elevator call buttons
•Signage
•Elevators (coordinate work with ongoing maintenance projects)

5



Upgrades to Toilet Rooms
Scope of work to include but not limited to:
•Reconfiguration of partitions to create accessible toilet rooms that accommodate:
•ADA compliant fixtures (toilets, urinals, lavatories)
•ADA compliant toilet accessories
•Code compliant fixture counts per building occupancy
•New finishes at all surfaces
•New lighting

6



Upgrades to exterior accessible path of travel
Scope of work to include but not limited to:
•New ramping with handrails
•New stairs with handrails
•Signage
•Path of travel lighting
•Upgrades to accessible path of travel from ADA parking to front door.
•Upgrades to parking layout and pavement

7



Area of landscape and hardscape upgrades made necessary by structural retrofit
Scope of work to include but not limited to:
•Repair of landscape impacted by exterior structural interventions
•Repair of hardscape impacted by exterior structural interventions
•Repair of accessible path of travel impacted by structural interventions (see above for details)

8

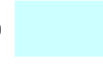

Area of roof repairs made necessary by structural retrofit
Scope of work to include, but not limited to:
•Total replacement of existing roof

Fire Life Safety Triggered Upgrades

- Provide emergency responder radio coverage at entire building (subject to determination by fire code official)
- Provide automatic and manual fire alarm system in holding cells (Group I-3 Occupancy)

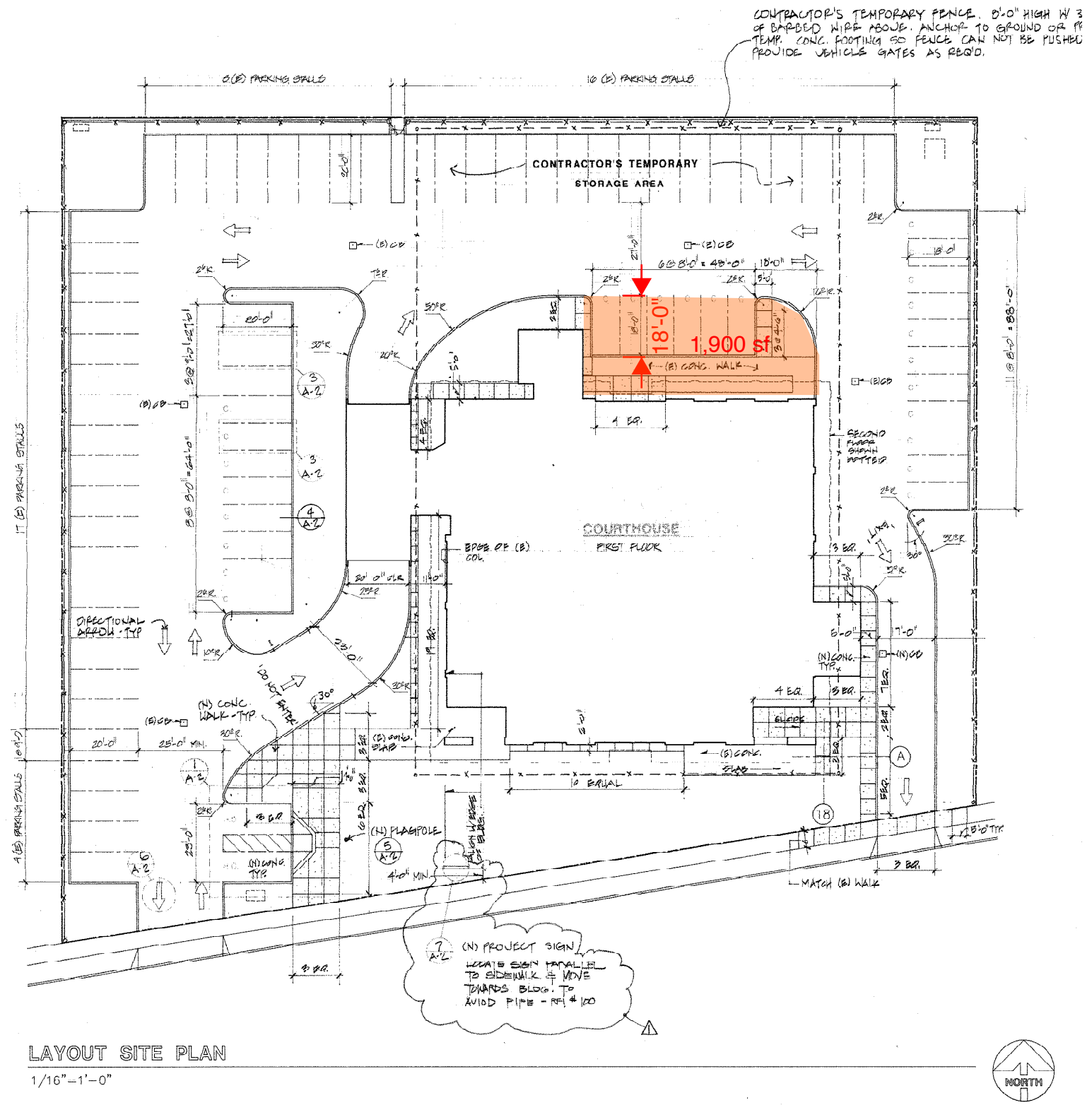

Sketch No: **A1.00 - SITE PLAN**

Retrofit: ALAMEDA
Scale: NTS

JUDICIAL COUNCIL
01-F1
Description: **ARCHITECTURAL UPGRADES**
GEORGE E. McDONALD HALL OF JUSTICE
CO Project # 17021.100

LEGEND

- | | | | | | | | | | | | |
|--|------------------------------|--|--------------------|--|-----------------|--|--------------------------|--|-----------------|--|--|
| | STRUCTURAL RETROFIT INTERIOR | | SPRINKLER UPGRADES | | REPAIR | | FULL INTERIOR RENOVATION | | ROOF REPAIR | | UPGRADES TO INTERIOR ACCESSIBLE PATH OF TRAVEL |
| | STRUCTURAL RETROFIT EXTERIOR | | ELEVATOR | | FINISH UPGRADES | | TOILET ROOM UPGRADES | | EXTERIOR REPAIR | | UPGRADES TO EXTERIOR ACCESSIBLE PATH OF TRAVEL |

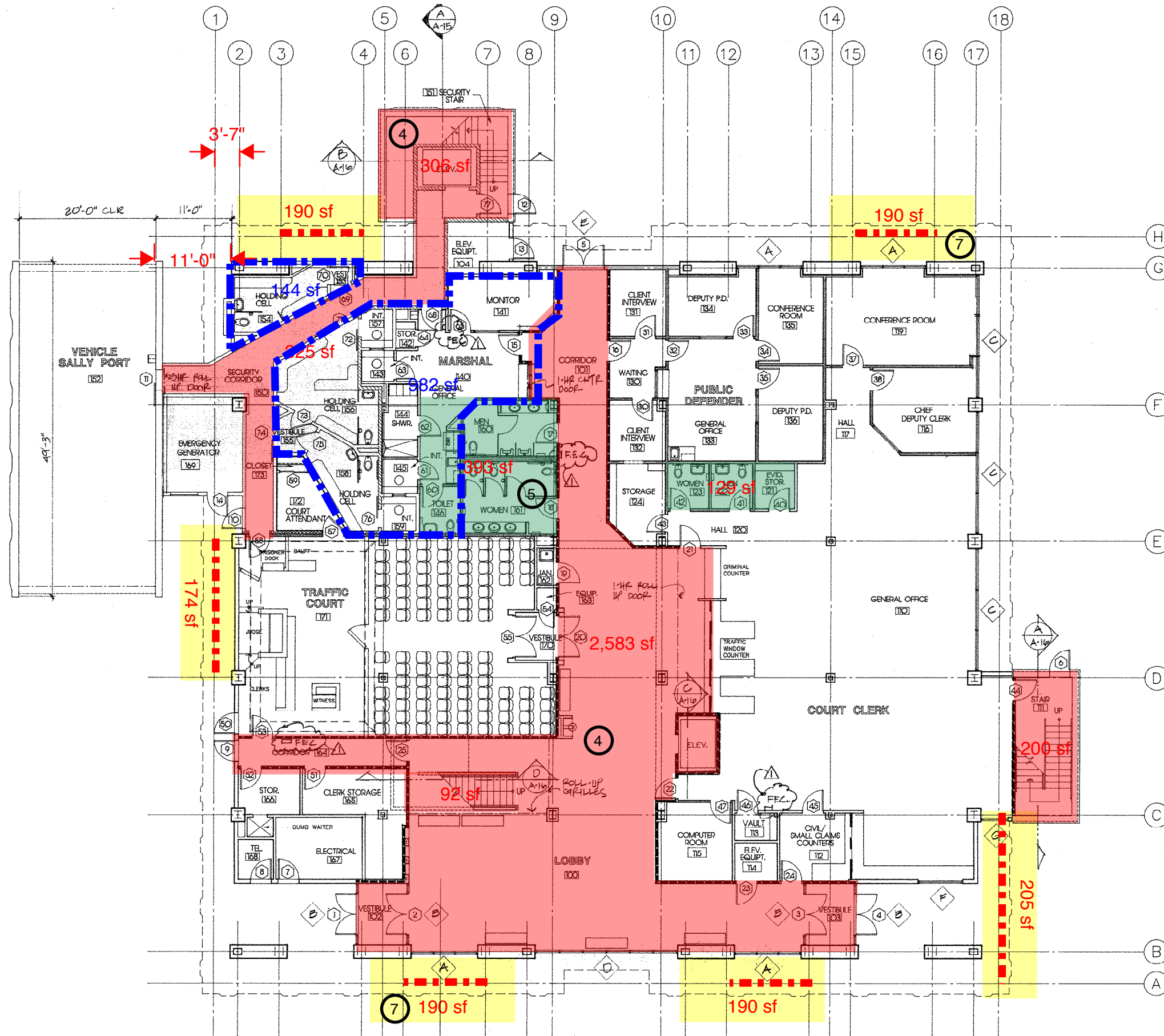

Sketch No: A1.01 - FIRST FLOOR PLAN

Retrofit: ALAMEDA
Scale: NTS

JUDICIAL COUNCIL
01-F1

DESCRIPTION: ARCHITECTURAL UPGRADES
GEORGE E. McDONALD HALL OF JUSTICE
CO Project # 17021.100

5055 Wilshire Boulevard, 9th Floor
Los Angeles, California 90034
323.525.0500 phone, 323.525.0955 fax



LEGEND

- STRUCTURAL RETROFIT INTERIOR

- - - - STRUCTURAL RETROFIT EXTERIOR
- SPRINKLER UPGRADES

✱ ELEVATOR
- REPAIR

□ FINISH UPGRADES
- FULL INTERIOR RENOVATION

□ TOILET ROOM UPGRADES
- ROOF REPAIR

□ EXTERIOR REPAIR
- UPGRADES TO INTERIOR ACCESSIBLE PATH OF TRAVEL

□ UPGRADES TO EXTERIOR ACCESSIBLE PATH OF TRAVEL

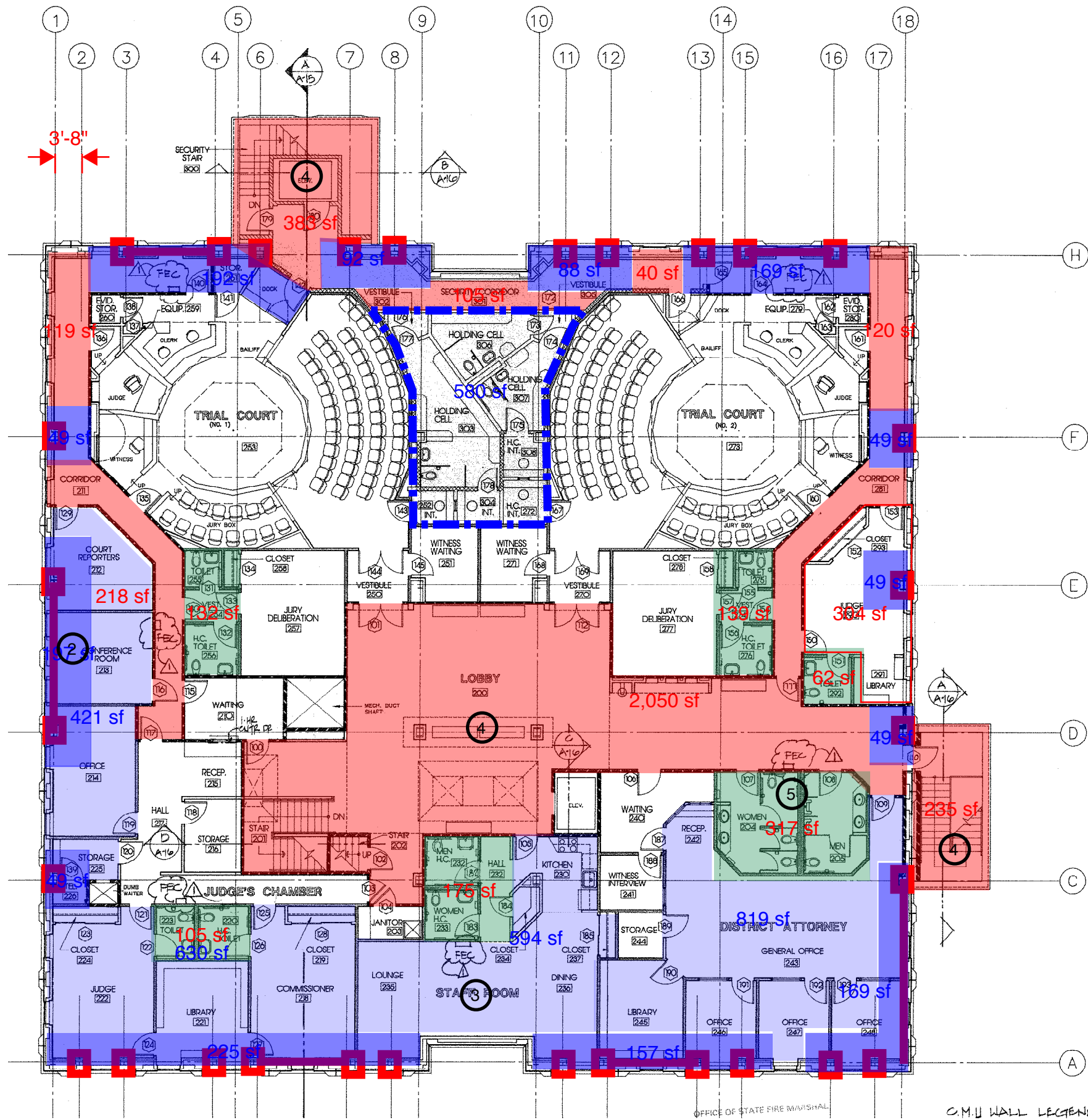

Sketch No: **A1.02 - SECOND FLOOR PLAN**

Retrofit: ALAMEDA
Scale: NTS

JUDICIAL COUNCIL
01-F1

DESCRIPTION: **ARCHITECTURAL UPGRADES**
GEORGE E. McDONALD HALL OF JUSTICE
CO Project # 17021-100

5055 Wilshire Boulevard, 9th Floor
Los Angeles, California 90034
323.525.0500 phone, 323.525.0955 fax



LEGEND

- STRUCTURAL RETROFIT INTERIOR
- SPRINKLER UPGRADES
- REPAIR
- FULL INTERIOR RENOVATION
- ROOF REPAIR
- UPGRADES TO INTERIOR ACCESSIBLE PATH OF TRAVEL
- - - STRUCTURAL RETROFIT EXTERIOR
- ✱ ELEVATOR
- FINISH UPGRADES
- TOILET ROOM UPGRADES
- EXTERIOR REPAIR
- UPGRADES TO EXTERIOR ACCESSIBLE PATH OF TRAVEL

Seismic retrofit package

The structural sheets in this section describe the seismic retrofit scheme for the existing courthouse facility. Note that this retrofit scheme applies to only Options 1, 2, and 3. Refer to sheet GN1 of the General Notes for an overview of each retrofit option.

Contents

S001	Table describing critical seismic deficiencies and the specific retrofit details designed to address them
S101-S103	Structural plan drawings for seismic retrofit scheme
S201	Structural details for the seismic retrofit scheme

Job: Judicial Council	Job #: 259713
Title: 01-F1 George E. McDonald Hall of Justice Seismic retrofit scheme	
Prepared By: KC	Page: S0
Sketch #: Structural notes	ARUP
Date: 2018-06-25	
Scale: NTS	
Original paper size: 11" x 17"	

Item	Description of deficiency	Description of retrofit measure
1	Interstorey drift is too high	Add BRBFs as the main seismic system and limit drift to 1%
2	Perimeter frames are discontinuous and therefore ineffective	Add BRBFs as the main seismic system and limit drift to 1%
3	Nonstructural: Concrete panels are heavy and not well-connected	Add additional anchors to connect panels to structure
4	to the structure	
5	Nonstructural: Stairs are not detailed to accommodate interstorey drift	Add BRBFs as the main seismic system and limit drift to 1%

Job: Judicial Council	Job #: 259713
Title: 01-F1 George E. McDonald Hall of Justice	
Seismic retrofit scheme	
Prepared By: KC	Page: S001
Sketch #: Retrofit Table	ARUP
Date: 2018-06-25	
Scale: N.T.S.	
Original paper size: 11" x 17"	

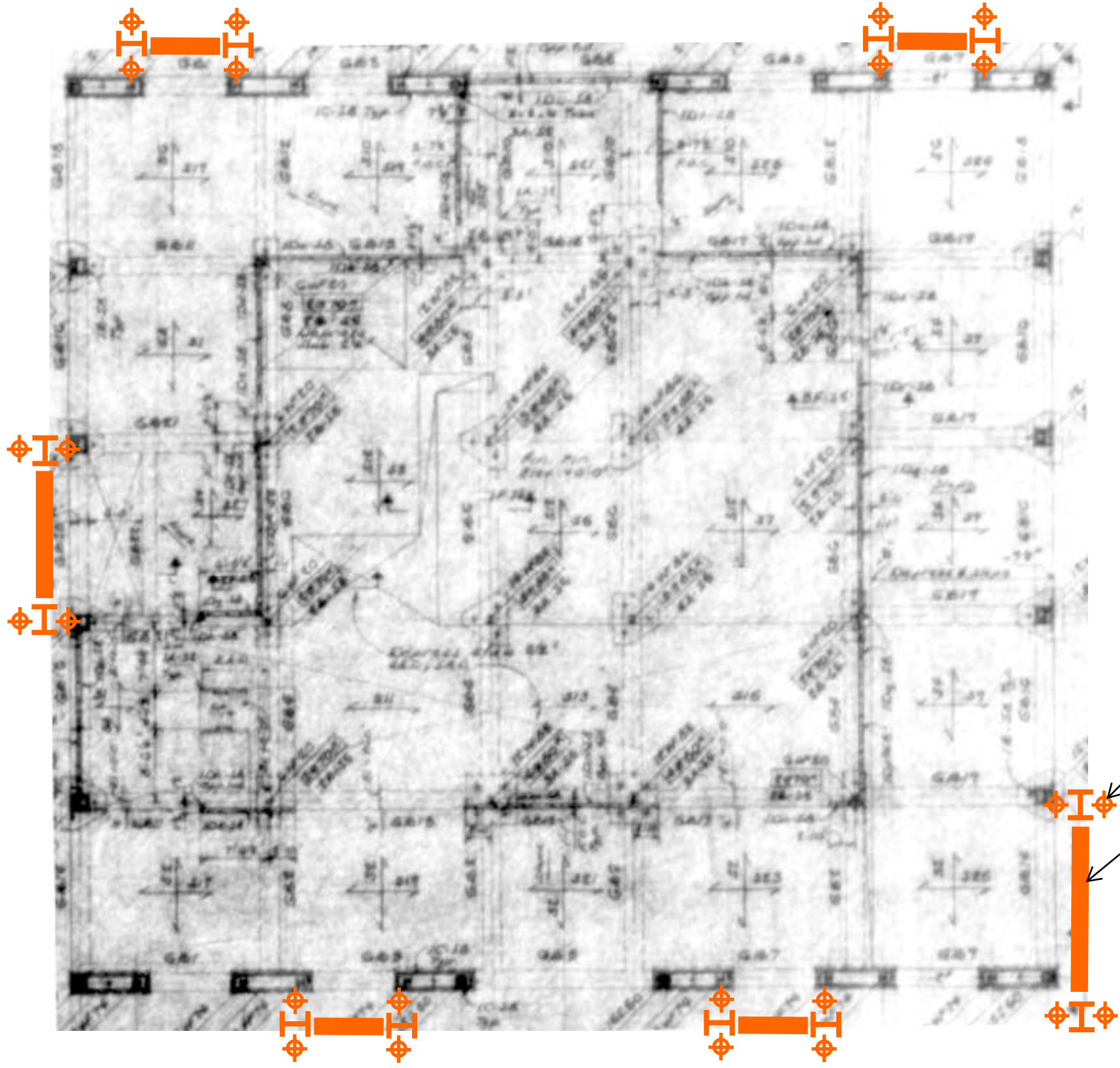

(N) W12 columns and micro-piles at BRBF

(N) BRBF, typical all floors

Job: Judicial Council	Job #: 259713
Title: 01-F1 George E. McDonald Hall of Justice	
Seismic retrofit scheme	
Prepared By: KC	Page: S101
Sketch #: Foundation Plan	
Date: 2018-06-25	
Scale: N.T.S.	
Original paper size: 11" x 17"	



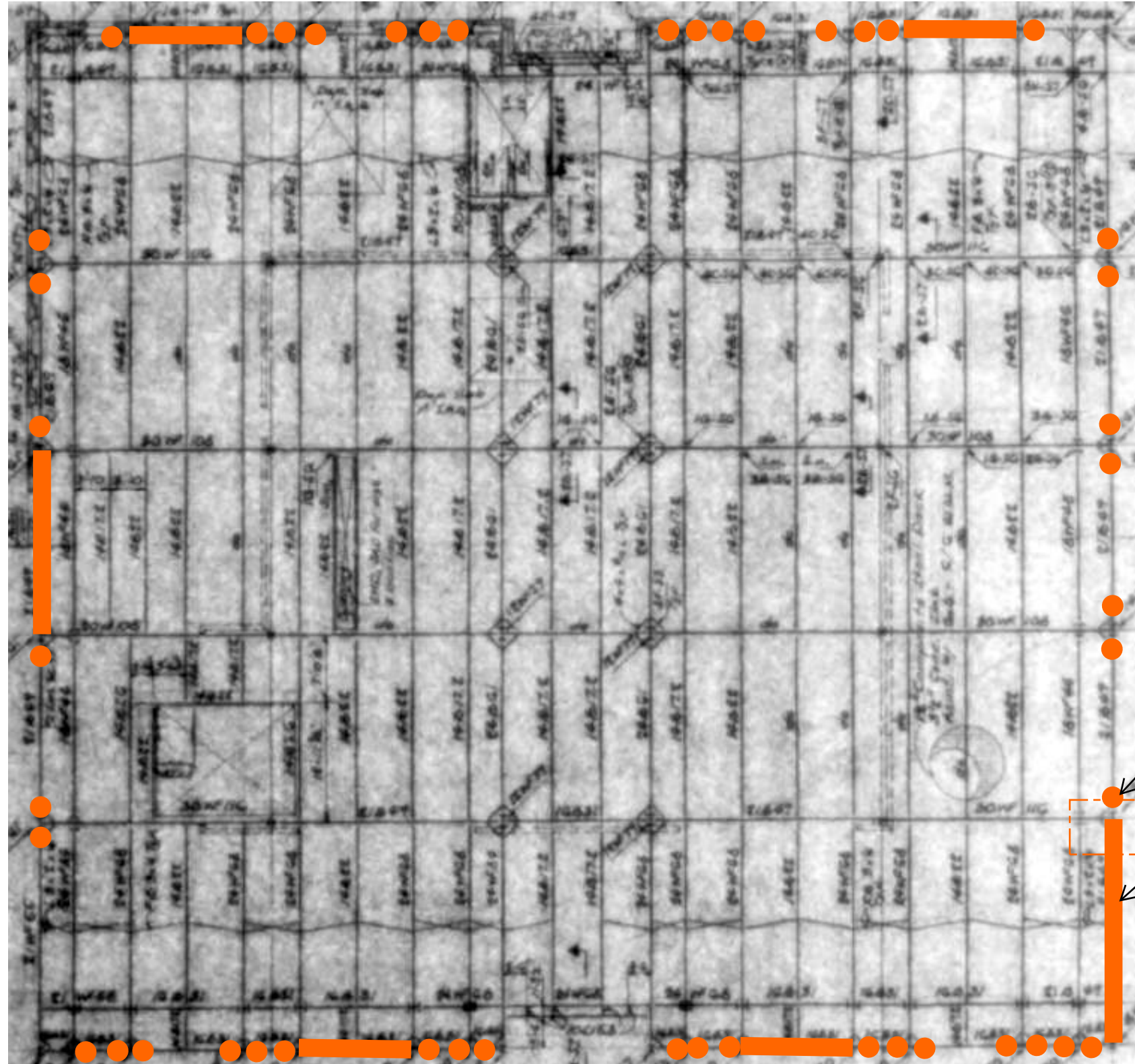

Strengthen (E) beam-column connection per detail 2/S201, typ

Strengthen (E) columns at (N) BRBFs per detail 3/S201, typ all columns

(N) BRBF, typical all floors

Job: Judicial Council	Job #: 259713
Title: 01-F1 George E. McDonald Hall of Justice	
Seismic retrofit scheme	
Prepared By: KC	Page: S102
Sketch #: 2nd Floor Plan	
Date: 2018-06-25	
Scale: N.T.S.	
Original paper size: 11" x 17"	





Strengthen beam-column connection per detail 2/S201, typ

(N) BRBF, typical all floors

Job: Judicial Council	Job #: 259713
Title: 01-F1 George E. McDonald Hall of Justice	
Seismic retrofit scheme	
Prepared By: KC	Page: S103
Sketch #: Roof Plan	
Date: 2018-06-25	
Scale: N.T.S.	
Original paper size: 11" x 17"	



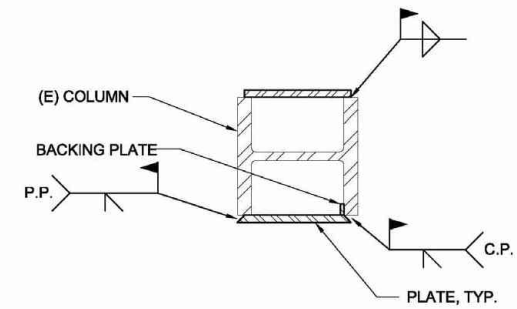

Note:
Welds shown indicate alternate possibilities of plate attachment.

Figure 8.4.3-2: Box Section at Existing Column

NOTE: COLUMN STRENGTHENING NEEDS TO BE CONTINUOUS THROUGH THE FLOOR SLAB.

3 COLUMN STRENGTHENING DETAIL

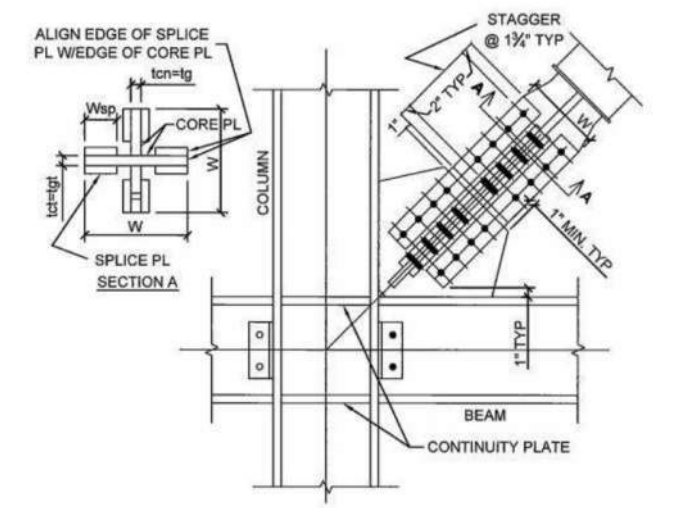

DETAIL BY COREBRACE

1 BRBF CONNECTION DETAIL

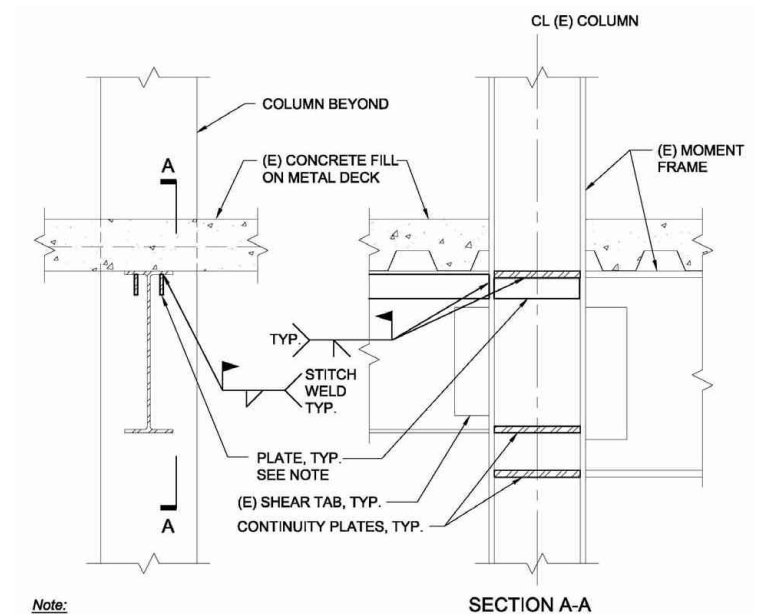

Note:
Plates may be interrupted at column by shear tab from transverse beam. Provide complete joint penetration welds from plates to shear tab.

Figure 8.4.4-1: Plate Collectors at Existing Beam

2 COLLECTOR RETROFIT AT BEAM

Job: Judicial Council	Job #: 259713
Title: 01-F1 George E. McDonald Hall of Justice	
Seismic retrofit scheme	
Prepared By: KC	Page: S201
Sketch #: Retrofit Details	ARUP
Date: 2018-06-25	
Scale: N.T.S.	
Original paper size: 11" x 17"	

APPENDIX D. COST ESTIMATION PACKAGE

Seismic Renovation Project Feasibility Report
George E. McDonald Hall of Justice (01-F1)

Appendix D provides a detailed cost breakdown for the selected retrofit option (i.e., baseline retrofit) for the George E. McDonald Hall of Justice. Cost estimates were developed to Class 3 of the American Association of Cost Engineers.

01-F1 George E. McDonald Hall of Justice Cost Assessment

	ITEMIZED COSTS			Option 2 - Priority Upgrades				Notes	
	SF	\$/SF	TOTAL \$ x 1,000	SF	\$/SF	TOTAL \$ x 1,000	%		
I. RETROFIT OPTIONS									
B1	Seismic - Minimum	8,550	878.01	7,507	24,870	301.85	7,507		
B2	Accessibility - Primary	10,099	155.96	1,575	24,870	63.33	1,575		
B3	Accessibility - Full	25,850	0.00	0	-				
B4	Fire Life Safety - Minimum	8,673	177.33	1,538	24,870	61.84	1,538		
B5	Fire Life Safety - Full	25,850	0.00	0	-				
B6	Non-Structural - Minimum	25,850	120.04	3,103	24,870	124.77	3,103		
B7	Building Systems - Priority Only	10,914	147.15	1,606	24,870	64.58	1,606		
B8	Full Renovation	25,850	391.30	10,115					
B9	Hazardous Material Abatement	25,850			24,870	0.00	0		
B10	Historical	25,850			24,870				
TOTAL RENOVATION COSTS (Cost / Impacted GFA)				14 MOS	24,870	616.37	15,329		
Z30	Escalation Is Not Included								
Z40	Soft Costs								
RECOMMENDED PROJECT BUDGET (Scenario 1) July-18				14 MOS	24,870	616.37	15,329	50%	<i>Facility closed during construction (all options)</i>
P1	Phasing Premium			15%	24,870	92.45	2,299		
P2	Schedule Premium			4 MOS	24,870	20.10	500		
P3	Escalation Premium			1.67%	24,870	10.27	255		
TOTAL CONSTRUCTION COSTS (Cost / Overall Existing GFA)					24,870	739.20	18,384		
Z30	Escalation Is Not Included								
RECOMMENDED PROJECT BUDGET (Scenario 2) July-18				18 MOS	24,870	739.20	18,384	60%	<i>Facility open during construction (all options)</i>

01-F1 George E. McDonald Hall of Justice Cost Assessment

	ITEMIZED COSTS			Option 2 - Priority Upgrades				Notes
	SF	\$/SF	TOTAL \$ x 1,000	SF	\$/SF	TOTAL \$ x 1,000	%	
Assumptions:								
1.	Full Renovation Option							Cost model shows optional premium costs to keep facility open & operational (Scenario 2) - note that there will be significant additional costs associated with temporary relocation of courts program while construction work is completed.
Notes:								
1.	Total Renovation Costs							This cost includes all trade costs plus general contractor general conditions, general requirements, bonds and insurance and design contingency
2.	P1 Phasing Premium							The phasing premium is to account for the building remaining open and operational during the course of construction. While a specific phasing plan will need to be developed once the project moves into actual design, the assumption is that the general contractor will be required to undertake the work in multiple phases and with significant working restrictions. Certain work may be required to be done outside of normal working hours, and shift work may be necessary. Temporary works will also be likely for protecting the public and staff and for mitigation against noise and dust disruption.
3.	P2 Schedule Premium							The schedule premium is to account for an extended construction duration due to phasing requirements. The cost covers additional general conditions and general requirements, calculated at \$125,000 per month
4.	P3 Escalation Premium							The escalation premium is to account for the added trade cost due to the extended construction duration. The cost covers higher overall labor and material costs due to the longer duration on site and the extended midpoint of construction which is used to calculate future cost escalation. This is calculated at an annual rate of escalation of 5.0%.
5.	Project Soft Costs							Excluded
Exclusions:								
1.	Costs for temporary relocation of programs and personnel							
2.	Cost of land for replacement building cost							
3.	Cost escalation (from the date of the cost plan to start of construction)							



01-F1 George E. McDonald Hall of Justice Cost Assessment Control Quantities & Areas by Options

Priority Upgrades		Parameters - EXISTING FACILITY	
	SF	% (Existing GFA)	
EXISTING GROSS FLOOR AREA IMPACTED	24,870	96%	Renovation Area (based on Existing GFA)
Areas			Existing Gross Floor Area 25,850 SF
Area of Repair (Retrofit from Interior)			Building Height 27 LF
Level 1	0		Roof Area 13,640 SF
Level 2	1,515		Building Perimeter : 758 LF
			Exterior Wall Area : 16,737 SF
			Number of Story Above: 2 EA
			Number of Story Below : 0 EA
			Number of Elevators: 1 EA
<hr/>			
Subtotal Area of Repair (Retrofit from Interior)		1,515	
Area of Repair (Retrofit from Exterior)			Number of Courts: 3 Courts
Level			Number of Judges' Chamb: 3 EA
			Number of Jury Room: EA
			Number of Holding Cells:
<hr/>			
Subtotal Area of Repair (Retrofit from Exterior)		0	
Area of Finish Upgrades			
Level 1	0		
Level 2	2,435		
<hr/>			
Subtotal Area of Finish Upgrades		2,435	
Area of Toilet Rooms Upgrades			
Level 1	522		
Level 2	904		
<hr/>			
Subtotal Area of Toilet Room Upgrades		1,426	
Area of Interior Accessible Path of Travel			
Level 1	3,513		
Level 2	3,260		
<hr/>			
Subtotal Area of Interior Accessible Path of Travel		6,773	
Area of Fire Life Safety Upgrades			
Level 1	1,123		
Level 2	684		
<hr/>			
Subtotal Area of Interior Accessible Path of Travel		1,807	



01-F1 George E. McDonald Hall of Justice Cost Assessment Control Quantities & Areas by Options

Priority Upgrades		Parameters - EXISTING FACILITY	
	SF	% (Existing GFA)	
Roof Upgrades			
Repair	4,301		
Upgrades			
Subtotal Area of Roof Repair and Upgrades		4,301	
Area of Façade Replacement			
Ground Floor - Level 2	3,456		
Subtotal Area of Façade Replacement		3,456	
Area of Exterior Accessible Path of Travel			
Level 1	1,900		
Subtotal Area of Exterior Accessible Path of Travel		1,900	
Additional Renovation Area			
Level 1	6,072		
Level 2	4,842		
		10,914	
TOTAL IMPACTED SURFACE AREAS (Floor + Façade + Roof)		34,527	0

APPENDIX E. R+C PEER REVIEW LETTER

Seismic Renovation Project Feasibility Report
George E. McDonald Hall of Justice (01-F1)

Appendix E provides a letter from Rutherford + Chekene, structural peer reviewer to the Judicial Council, stating their professional opinion about overall appropriateness or validity of the conceptual retrofit scheme proposed by consultant team for the George E. McDonald Hall of Justice.



7 January 2019

Clifford Ham
Senior Project Manager & Architectural Program Lead
Facilities Services Office
Judicial Council of California
455 Golden Gate Avenue
San Francisco, CA 94102
Clifford.Ham@jud.ca.gov

2018-032S, Task 1

Subject: **CALIFORNIA SUPERIOR COURT BUILDINGS SEISMIC RENOVATION
FEASIBILITY STUDIES
SEISMIC PEER REVIEW FINDINGS**

Dear Mr. Ham:

On behalf of the Judicial Council of California, Rutherford and Chekene performed Seismic Peer Review for the Court Renovation Feasibility Studies project. The purpose of this project was to create individual Project Feasibility Reports defining the feasibility, scope and budget for renovation construction to mitigate the seismic safety risks in 26 existing superior court facilities with very high or high seismic risk ratings.

Each study involved developing a conceptual seismic retrofit scheme, determining the collateral impacts and associated construction costs of the retrofit scheme and renovation options, and performing cost-benefit analyses to determine the most appropriate renovation strategy for the subject facility. A total of five retrofit and replacement options were considered for each facility. In addition to a seismic retrofit only project (option 1), additional options were developed that included seismic retrofit with priority building infrastructure and systems upgrades (option 2), seismic retrofit with full building renovation (option 3), building replacement (option 4), and building replacement with enhanced performance (option 5). The consultant team then performed costs-benefit analyses to compare the financial effectiveness of the five retrofit and replacement options for each facility. The benefit-cost ratio was the primary consideration of the Judicial Council Facilities Services staff's decision of which retrofit or replacement option to select.

The goal of the peer review was to advise the Judicial Council Facilities Services on the validity of structural engineering performance criteria for the strategic approaches to building renovation, e.g. Life-Safety, Current Code, Enhanced Performance, and the validity of the structural engineering design concepts proposed by Consultant for the building renovations.

This letter summarizes our findings related to the methodology used to develop the retrofit concepts and calculate Benefit-Cost Ratios for the various options considered for each facility, and our findings regarding the validity of the engineering design concept for the building renovation/ retrofit to meet the intended seismic performance level.

FINDINGS

1. The project used the ASCE 41-13 Basic Performance Objective for Existing Buildings for Risk Category II buildings as the Structural Design Criteria for evaluation and retrofit design.

This seismic performance objective is considered equivalent to (and therefore achieves) Risk Level IV performance, which is the minimum performance level required by the Judicial Council of California for the seismic retrofit of court buildings and meets the minimum requirements of the 2016 California Existing Building Code (CEBC) for State Owned Buildings, as stated in Table 317.5 of CEBC - California Code of Regulations – Title 24, Part 10.

2. The consultant team used the ASCE 41-13 Tier 1 Screening procedure and the most recent seismic hazard information for California, supplemented with numerical checks of the adequacy of the load path and seismic force-resisting system to evaluate each building. Based on the deficiencies identified by this seismic evaluation, the consultant team developed a conceptual retrofit scheme to mitigate each deficiency.
3. The scope of architectural impacts and triggered improvements is extensive, and constitutes a significant portion of the retrofit costs.
4. The seismic retrofit drawings incorporate standard structural details, typically taken from the FEMA document "*Techniques for the Seismic Rehabilitation of Existing Buildings*", FEMA 547. Though these details may not reflect the actual construction of the court building and are not developed in enough detail for the purpose of construction, they are typically adequate to convey the intent of the retrofit to the cost estimator.
5. Some of the facilities such as the Central Justice Center (30-A1), the Glendale Courthouse (19-H1), the Imperial County Courthouse (13-A1), the Napa Courthouse (28-B1), and the Wakefield Taylor Courthouse (07-A2) are local points of historic interest, or have historically significant architectural features. Though some attention was given to avoid modification of exterior appearance, interior public space and courtrooms when developing the retrofit concept, it may be expected that the final retrofit design would focus on localizing the retrofit work to the extent possible and would consider additional retrofit schemes to further reduce the impact of the retrofit construction on the historically significant elements.
6. The calculation of seismic benefit-cost ratios is primarily based on the method published in the FEMA document "*Seismic Performance Assessment of Buildings*", FEMA P-58. The method is comprehensive and relatively complex and requires development of many input parameters. The scope of the feasibility studies was limited, requiring determination of many of the parameters more efficiently than recommended by the P-58 methodology, often essentially by engineering judgment. As pointed out in the Detailed Methodology Report, many of the input parameters and resulting output have large uncertainties. Uncertainty is always present in seismic analysis and related calculations, largely due to the uncertainty in the ground motion itself. The methodology used in these reports takes uncertainty into account explicitly, enabling the user to study the potential effects of various uncertainties. Since the methods used for each building and each alternative (and related uncertainties) are consistent throughout the study, the relative values of the results should be sufficiently stable to be used for comparison of various actions.
7. Losses due to casualties are monetized using values common in the industry. However, the number of casualties estimated by the study is exceptionally high. This is due to use of a large occupancy (number of people in the building exposed to damage or collapse), derived from JCC counts of entries into each building. This method, in itself, is susceptible to double counting, but also many studies of the kind use the Equivalent Continuous Occupancy (ECO) which averages occupancy over 24 hour days and 7 day weeks. The ECO is

typically one third of the normal daytime occupancy. In addition, the casualties used to estimate benefit and costs was taken as the 90th percentile of the probabilistic calculation rather than the mean taken for other loss parameters. Studies documented in the Detailed Methodology Report indicate that the assumptions resulting in high casualties and monetized losses have little effect on relative values between options and between buildings and therefore do not invalidate the results of the study.

8. When considering a replacement building as an option, the size and construction cost of each replacement building was provided by the Judicial Council; the gross area is an estimate, subject to change with detailed design, but suitable for these reports. The configuration and structural system of the new building and its site on the other hand were unknown, and detailed loss models could not be developed as a result. Therefore, loss values for the replacement buildings were proportioned using linear scaling factors from losses calculated for the existing building. Although losses from a new building would normally be less than from an existing retrofitted building, it is unclear if all losses have the same proportionality or how variations in the reduced losses could affect the benefits of these options.
9. The benefit-cost ratios calculated in this study are relatively low, often below 1.0. One reason for this result is that there are high costs related to the non-seismic upgrades (e.g. sprinklers, disabled access, mechanical, etc.) required for most of these buildings. The total costs of installation of these systems are included in the “costs” but there are only small seismic-related “benefits,” and therefore the *seismic* cost-benefit ratios are lowered.

To an extent consistent with the scope of our review, our professional opinion is that the retrofit concept presented in this report when further developed into construction documents will be capable of achieving a Risk Level IV and minimum code requirements and is adequate for the purpose of developing conceptual cost estimates used for budget purposes.

We further find that the methodology and assumptions used to calculate cost-benefit ratios for the 5 retrofit and replacement option considered are reasonable and the results properly considered for the purposes of these studies.

SCOPE OF SERVICES

We carried out the Seismic Peer Review in accordance with the agreed upon scope of work, included in our Work Order No. 1035898 with the Judicial Council of California. The scope of our review is summarized below:

- Participated in regular meetings and conference calls between April and November 2018.
- Participated in a series of workshops where design assumptions, retrofit design concepts and benefit-cost ratios were presented and discussed.
- Reviewed submitted information and reports for each building, provided comments, and worked with the consultant team to reach resolution of comments.
- Issued a letter for each building stating our professional opinion about performance criteria for strategic approaches to building renovation/conceptual retrofit design.
- Provided a letter stating our professional opinion about overall appropriateness of the processes used for this project relative to current best engineering practices.



Mr. Clifford Ham
Judicial Council of California

7 January 2019
Page 4

Rutherford + Chekene staff participating in the review were Ayse Celikbas, William Holmes, Afshar Jalalian, and Marko Schotanus.

Please contact us at (415) 568-4400 if you wish to discuss any elements of the review.

Sincerely,

RUTHERFORD + CHEKENE

A handwritten signature in black ink, appearing to read 'Afshar Jalalian', written over a horizontal line.

Afshar Jalalian, S.E.
Executive Principal

cc: Michael Mieler, Rob Smith, Ibrahim Almufti – Arup, San Francisco